



More Precision

confocalDT // Confocal chromatic sensor system



Confocal chromatic displacement and thickness measurements

confocalDT

Highest precision in confocal chromatic displacement and thickness measurements

The confocalDT sensors product range stands for the highest precision and dynamics in confocal chromatic measurement technology. A large number of sensors and different interfaces can be used in versatile measurement tasks, e.g., in the semiconductor industry, glass industry, medical engineering and machine building.



- Configuration via web interface
- Adjustable measuring rate up to 30 kHz

- Robust sensors & drag-chain suitable cables
- Passive measuring principle ideal for vacuums

- Very small measurement spot size
- Accurate measurement with nanometer resolution

- Fast surface compensation
- For distance, thickness and multi-peak measurements

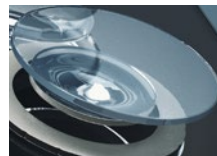
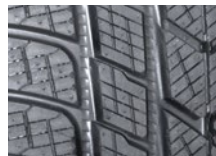

Shiny metals

Glass







Black rubber

Curved lenses

Overview

confocalDT

Compact systems		Measuring range	Measurement mode	Page
confocalDT IFD2410	Next generation confocal sensor system	1.0 mm ... 6.0 mm	Distance measurement Thickness measurements	10 - 11
confocalDT IFD2415	Best in class - Next-generation confocal sensor system	1.0 mm ... 10.0 mm	Distance measurement Thickness measurements Multi-peak measurement	12 - 13
confocalDT IFD2411	Compact confocal measuring system	1.0 mm ... 6.0 mm	Distance measurement Thickness measurements	14 - 15

Sensors		Measuring range	Measurement direction	Measurement mode	Page
confocalDT IFS2402	Confocal chromatic miniature sensors ø4 mm	0.5 mm ... 3.5 mm		Distance measurement	16 - 17
confocalDT IFS2403	Confocal chromatic hybrid sensors ø8 mm	0.4 mm ... 10 mm		Distance measurement Thickness measurements	18 - 19
confocalDT IFS2404	Confocal chromatic sensors ø12 mm	2 mm		Distance measurement Thickness measurements	20
confocalDT IFS2405	Precise confocal sensors ø27 - 62 mm	0.3 mm ... 30 mm		Distance measurement Thickness measurements	21 - 23
confocalDT IFS2406	Confocal chromatic sensors for displacement and thickness measurements ø20 - 27 mm	2.5 mm ... 10 mm		Distance measurement Thickness measurements	24 - 25
confocalDT IFS2407	High precision sensors for displacement and thickness measurements ø12 - 54 mm	0.1 mm ... 3 mm		Distance measurement Thickness measurements	26 - 27

Each sensor can be operated with every confocalDT controller.

Controller		Channels	Measuring rate	Page
confocalDT IFC242x	Confocal controller for industrial applications	1 or 2	up to 10 kHz	28 - 29
confocalDT IFC246x	Light-intensive controller for high speed measurements	1 or 2	up to 30 kHz	30 - 31

Accessories	Page
System design	32 - 33
Sensor solutions and vacuum feedthroughs	34
Mounting adapter	35
Adjustment adapter	36 - 39
Cables	40 - 41
Interface modules	42 - 43

Measuring principle and fields of application

confocalDT

The confocal chromatic measuring principle

Polychromatic white light is focused onto the target surface by a multilens optical system. The special lens arrangement splits the white light into monochromatic wavelengths by controlled chromatic aberration. To each wavelength, a specific distance is assigned by factory calibration. Only the wavelength which is exactly focused on the target is used for the measurement. An optical arrangement images the light reflected onto a light sensitive sensor element. This sensor element detects the corresponding spectral color and evaluates it. In the case of multi-peak measurements, several distance points are evaluated accordingly.

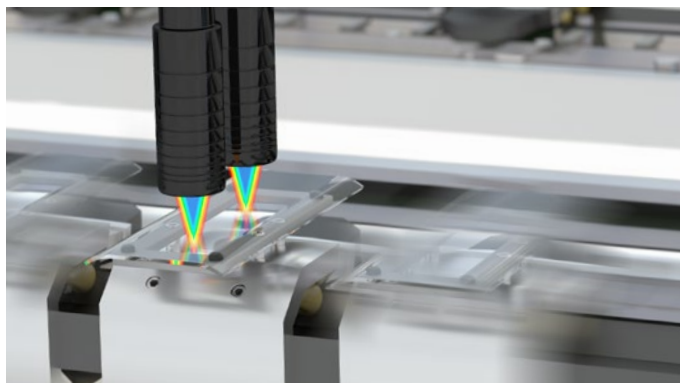

High measuring rate for dynamic measurement tasks

The confocalDT systems offer high measuring rates for measurement tasks with high dynamics. The controller dynamically regulates the exposure of the CCD line. This exposure control compensates for color and reflectivity changes of the measuring object in order to increase the measurement accuracy at high measuring rates.

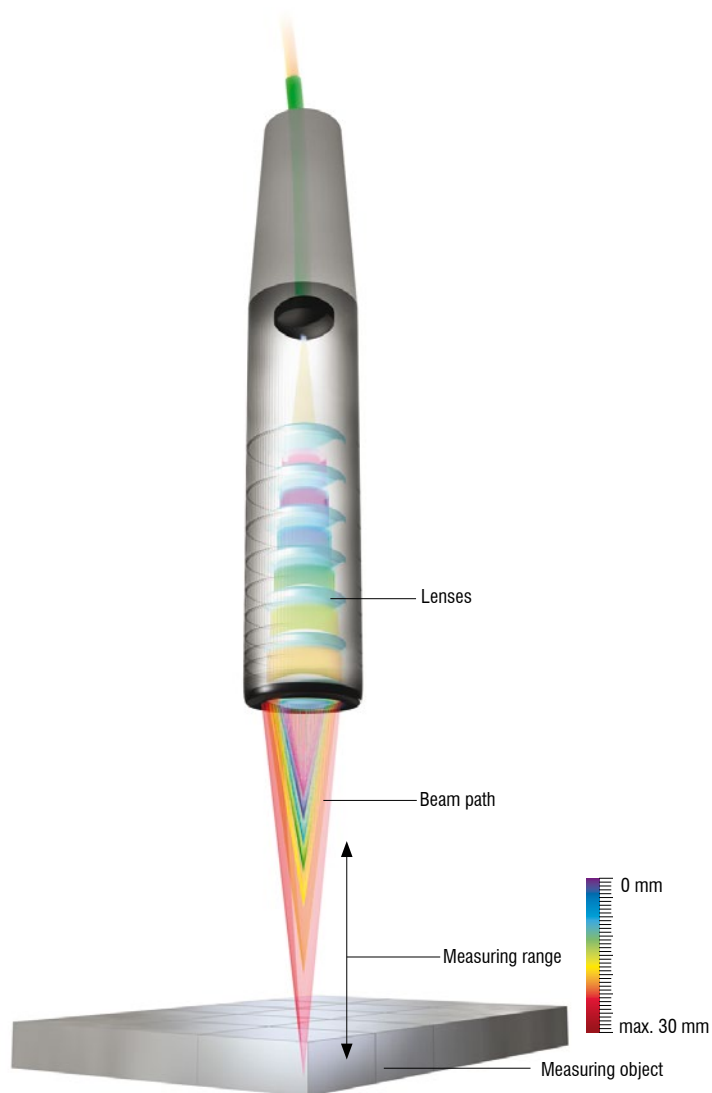

Three screenshots of the confocalDT web interface. The first shows a 'Video signal display' with a waveform. The second shows a 'Measurement chart' with a graph of 'Measuring range [mm]' vs 'Time range [s]'. The third shows 'Measurement configuration' and 'Signal quality' settings, including a slider for 'balanced' between 'static' and 'dynamic'.

Ease of use via web interface

Set up and configuration of controller and sensors is handled in a user-friendly web interface via Ethernet connection. No additional software is required. For thickness measurements, materials are stored in an editable materials database.



Compact sensors for restricted installation spaces

The compact design with diameters from 4 mm enables integration in restricted spaces. With the 90° models, the required installation depth is again significantly reduced.

Robust optical fibers for all applications

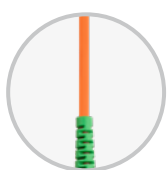

Standard fiber optics

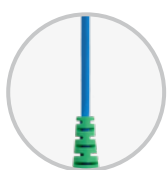

Drag-chain suitable fiber optics



Protective hose for mechanical stress



Robot-suitable fiber optics



Vacuum / UHV model

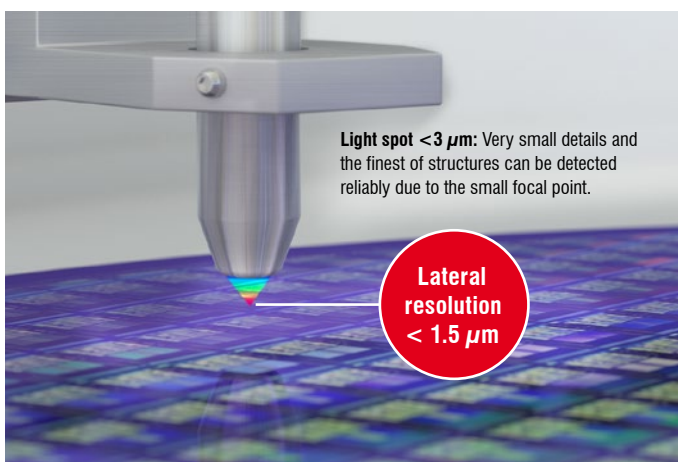

Smallest light spot for high lateral resolution

The confocalDT sensors are available with different aperture angles. A large aperture angle with a high numerical aperture (NA number) enables a small light spot (X-Y resolution) as well as a high Z-axis resolution, allowing the smallest details to be detected with high precision. The size of the light spot remains almost constant over the entire measuring range.



Large measuring angle – ideal for curved and structured surfaces

The confocalDT IFS sensors tolerate a large measuring angle up to 48°. Therefore, curved and structured surfaces can be detected reliably to generate stable signals.

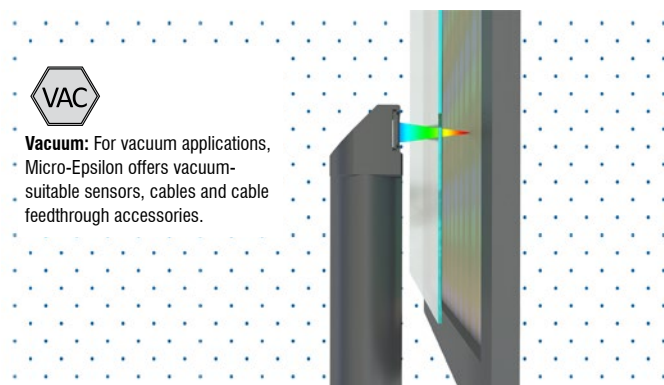

Vacuum applications

The confocalDT sensors consist of passive components and do not emit heat. For the use in vacuum, special sensors, cables and other accessories are available.

Absolute distance measurement confocalDT

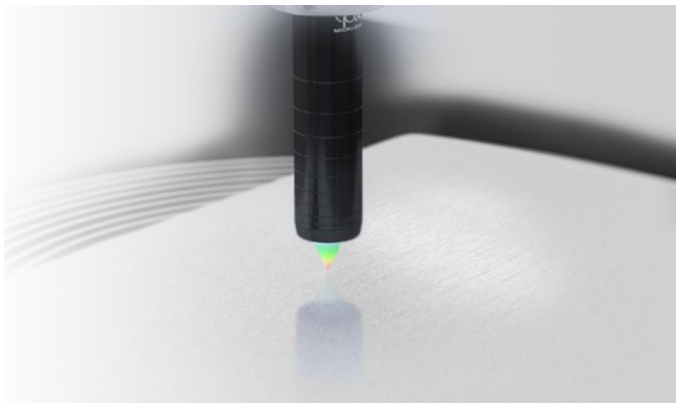

High-precision displacement and distance measurements on almost all types of surface

The confocal sensor systems from Micro-Epsilon are used for high-resolution displacement and distance measurements. Due to the innovative technology, measurements can be performed on both diffuse and specular surfaces with high stability. The high measuring rate also allows for high speed processes to be monitored reliably.

Distance measurement on transparent objects

High-precision distance measurement is required for contour measurement or positioning of glass lenses. The confocalDT sensors detect curved surfaces with a resolution of up to 18 nm. Thanks to their high measuring rate, the transparent targets can be measured at high speed.

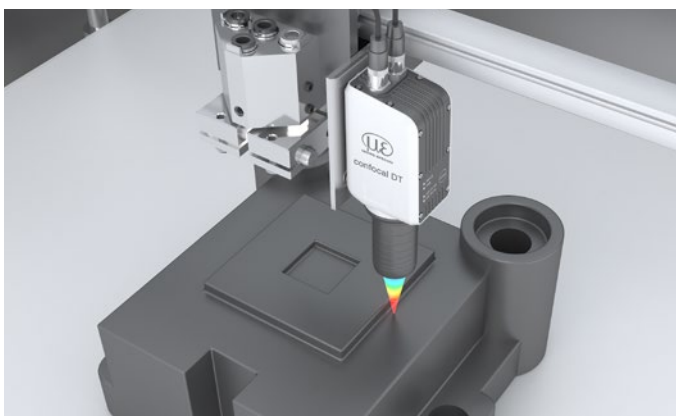
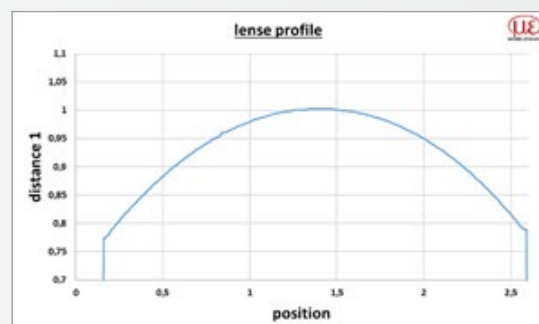

High precision distance control

In 3D printing of complex components as well as in PCB printing, precise positioning with submicrometer accuracy is essential. Here, confocal sensors are used. These detect the distance with the highest precision and at the same time a high measuring rate in order to be able to monitor even dynamic processes.

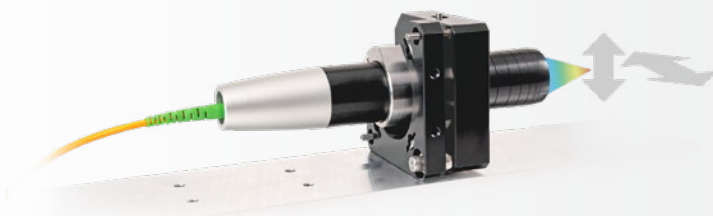

Mounting adapter for fine adjustment

To achieve orthogonal alignment of the sensor for high-precision distance measurements, a mounting adapter is available for fine adjustment.

Precise thickness measurement confocalDT

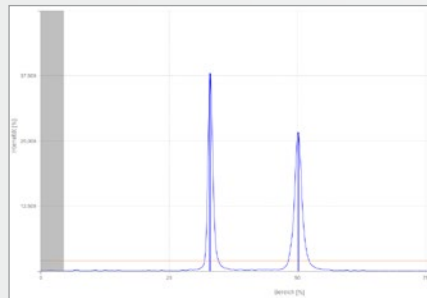
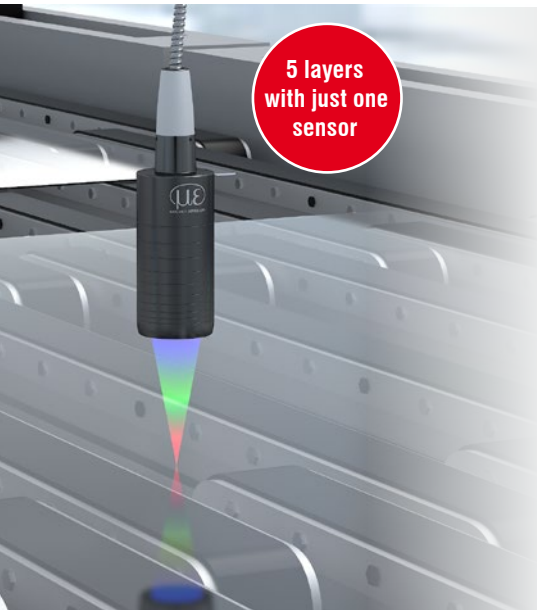

Thickness measurement signal

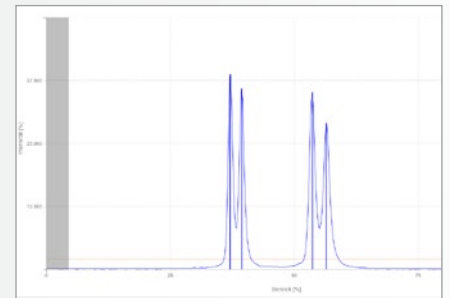

Signal with multi-layer thickness measurements (max. 6 peaks)

Thickness measurement of transparent materials in the micron range

The confocalDT sensors enable thickness measurements of transparent materials. A sensor detects the material thickness with micrometer precision. Thanks to the integrated multi-layer measurement, the thickness of multi-layer objects such as laminated glass can be evaluated.



Glass thickness measurement

The confocalDT sensors are ideally suitable for one-sided thickness measurement of transparent objects such as bottles. Therefore, thicknesses between 5 μm and 30 mm can be measured. Even curved contours such as the bottle neck or bottoms are precisely detected. The color of the bottle does not matter for this measurement. This allows 100% end-of-line quality control to be performed inline.

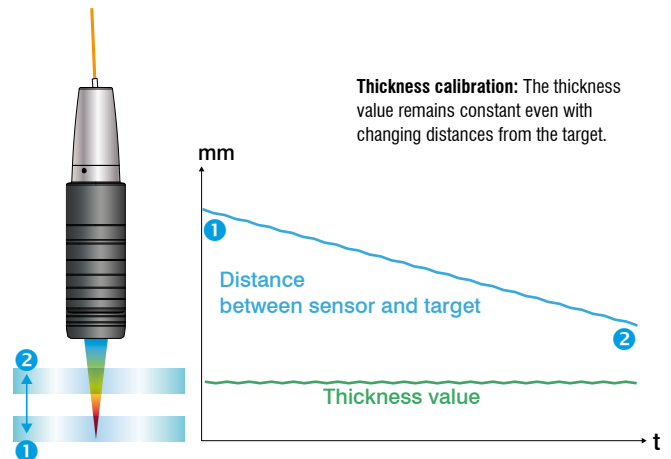

Thickness calibration: The thickness value remains constant even with changing distances from the target.

Thickness calibration for precise thickness measurements regardless of distance

Changing material thickness and a varying distance between the target and the sensor produce faulty measurement values. Therefore, confocalDT controllers from Micro-Epsilon offer a thickness calibration feature. By selecting the respective target material, the distance-dependent error is automatically compensated for which enables to achieve the highest possible measurement accuracy.

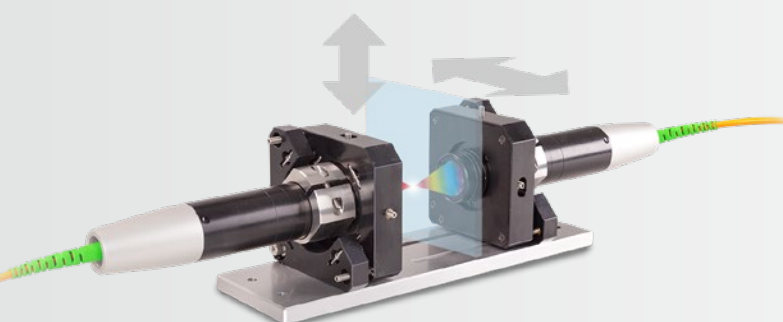

Mounting adapter for two-sided thickness measurements

The JMA-Thickness mounting adapter is used for the congruent alignment of two sensors.



Thickness measurement of displays and flat glass

Glass sheets for the production of displays require a homogeneous thickness profile. Confocal chromatic sensors from Micro-Epsilon determine the thickness without making contact from one side.

Recommended sensors: IFS2405

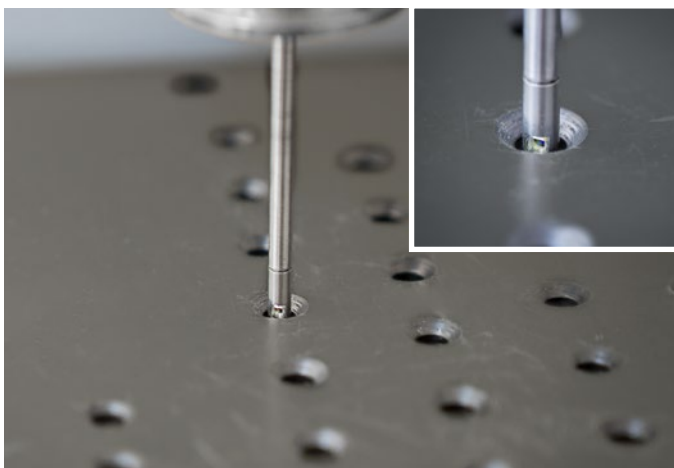

Restricted installation space

Miniature sensors with a diameter of 4 mm are suitable for measurements in confined installation spaces, e.g., for the inspection of boreholes. Furthermore, the 90° version of these sensors enables to measure the finest interior contours.

Recommended sensors: IFS2402

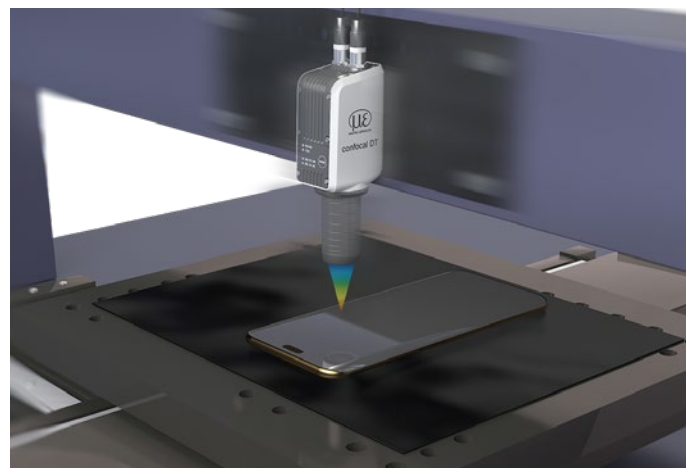

Coordinate measuring machines

The compact confocalDT 2410 / 2415 models have an integrated controller. Since no optical fiber is required, the space-saving sensor is particularly suitable for dynamic applications such as in measuring machines.

Recommended sensors: IFD2410 / IFS2415

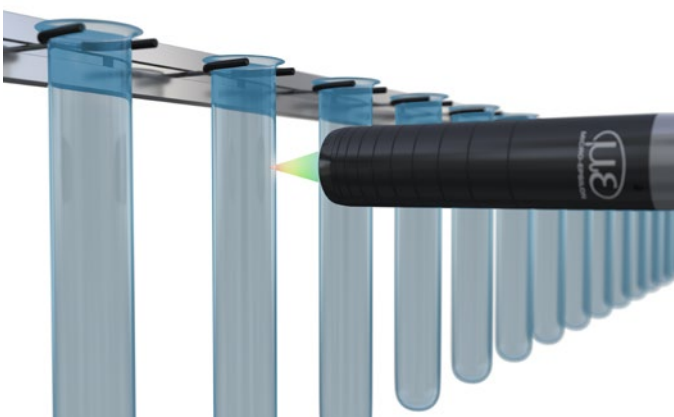

Wall thickness measurement of container glass

Wall thickness distribution is a crucial quality criterion for container glass. In order to determine the glass thickness of the bottom and the walls, confocal chromatic sensors from Micro-Epsilon are used. Measurements are performed without contact and at a high measuring rate.

Recommended sensors: IFS2406

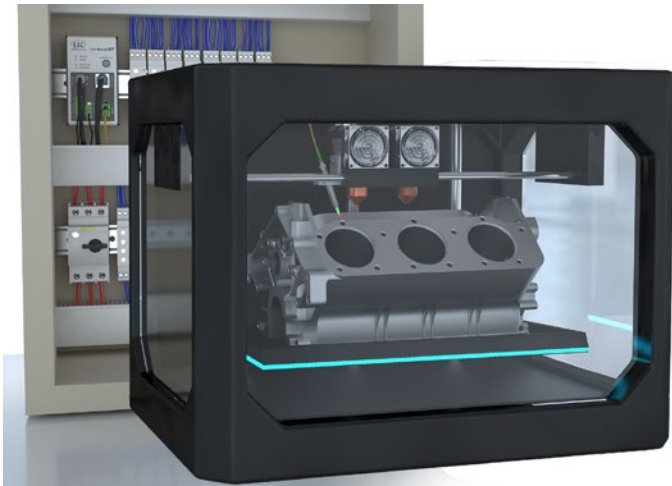

Displacement and distance measurements in 3D printing machines

The compact controllers of the confocalDT 2411 series are used for distance control in industrial printers. The sensor system impresses with a measuring rate of up to 8 kHz and a resolution of up to 12 nm. Due to their compact design, the controllers can be optimally integrated in the control cabinet.

Recommended sensors: IFD2411

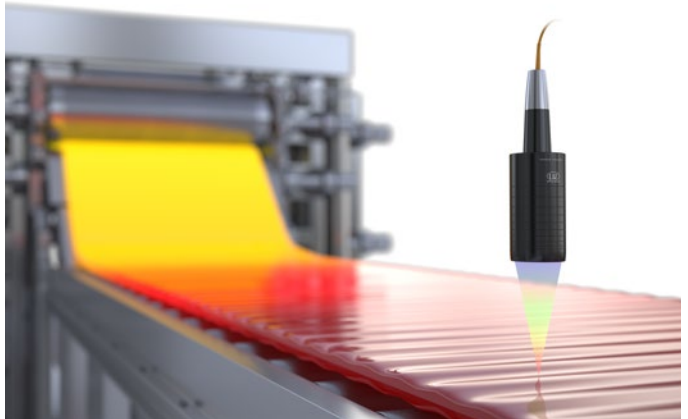

Measuring on hot glass

Confocal sensors can also be used for the measurement of hot glass. The large offset distance allows for the sensor to be mounted from a safe distance to the hot glass.

Recommended sensors: IFS2405-28

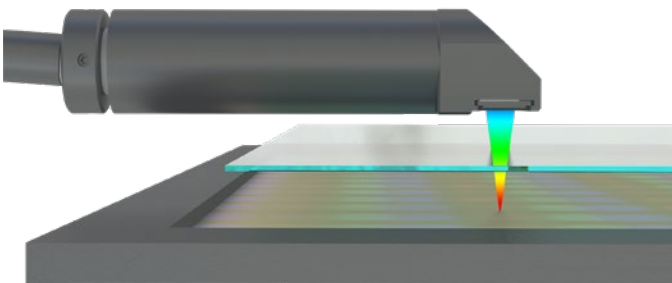

Positioning of glass masks

Confocal chromatic sensors monitor the gap between the mask and the glass. Thanks to the 90° design, the sensors can be integrated in an extremely space-saving manner.

Recommended sensors: IFS2406/90-2,5

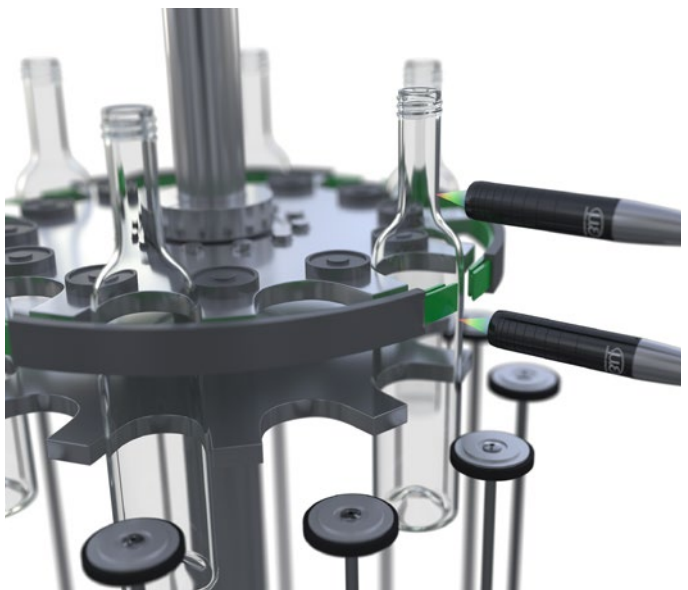





Thickness measurement on the star wheel

Fast dual-channel thickness measurement of glass bottles in the industrial production process.

Recommended sensors: IFS2406-10

Confocal chromatic sensor system with integrated controller

confocalDT IFD2410

-  All-in-One: sensor and controller in one compact housing (IP65)
-  Adjustable measuring rate up to 8 kHz
-  Simple integration without optical fibers
-  **INTERFACE** EtherCAT / PROFINET / EtherNet/IP / RS422 / Analog
-  Micron-precise measurement of distance and thickness

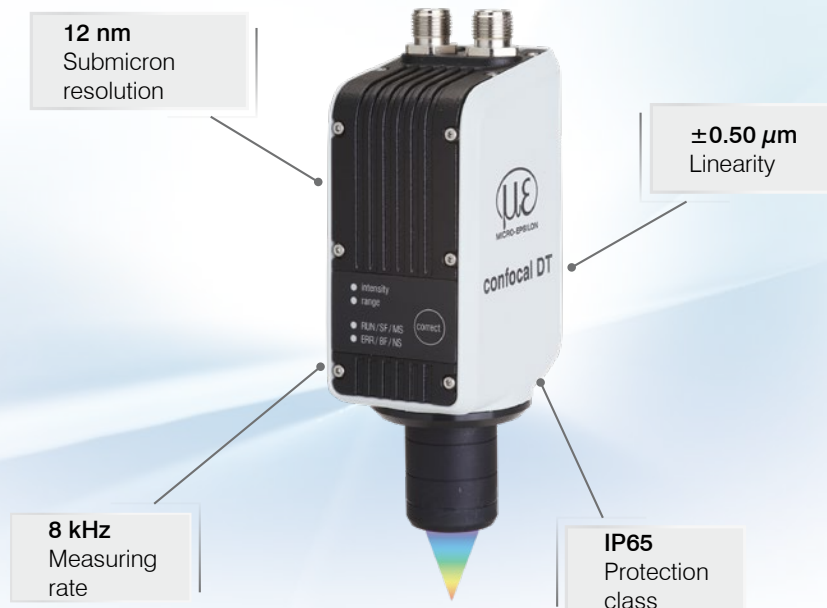

EtherCAT® PROFINET® EtherNet/IP®

All-in-One: compact confocal sensor with optimal price/performance ratio

The confocalDT IFD2410 is an innovative confocal sensor with integrated controller. The space-saving IP65-housing enables fast integration into plant equipment and machines as no optical fiber is required. This makes the IFD2410 ideally suited to high precision distance and thickness measurements in industrial series applications.

The active exposure regulation of the CCD line enables fast and accurate compensation of varying surfaces even in dynamic measurement processes up to 8 kHz. Based on its excellent price/performance ratio, the confocalDT IFD2410 sets a new benchmark in precise confocal measurement technology.

Intelligent technology meets high performance and user-friendliness

In Ethernet mode, the confocalDT IFD2410 can be set via the intuitive web interface. Industrial Ethernet ensures that the settings are automatically applied to the PLC environment. This eliminates time-consuming setting efforts in the programming environment.

Fast, precise and compact

Its high performance and compact housing make this sensor ideally suitable for series applications in production lines and machines. These include inline inspection and coordinate measuring machines, inline thickness monitoring of flat glass and container glass as well as testing electronic components.

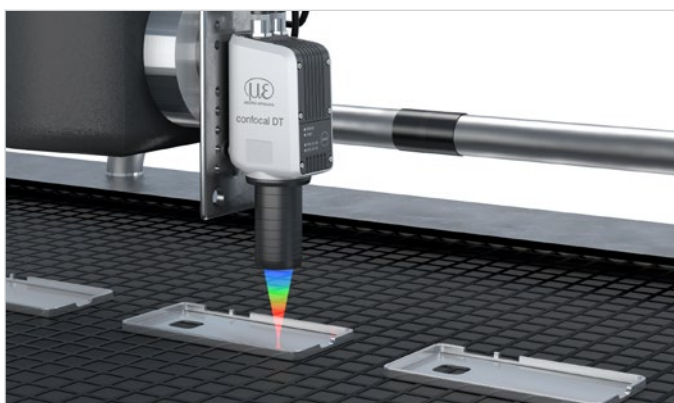

Inline measurement of smartphone housings



Simple parameter set up via integrated web interface

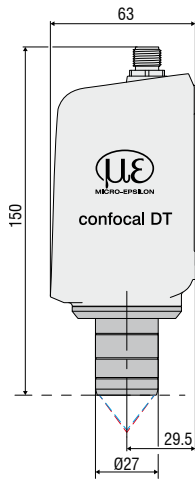

Dimensions in mm,
not to scale.

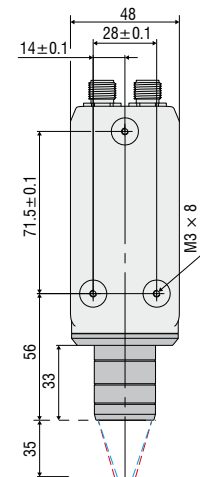
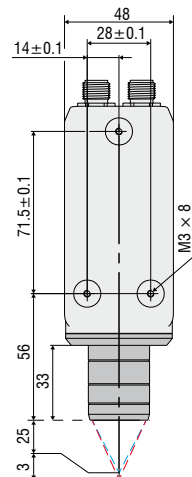
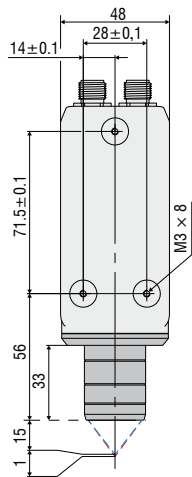

Model		IFD2410-1	IFD2410-3	IFD2410-6
Measuring range		1.0 mm	3.0 mm	6.0 mm
Start of measuring range	approx.	approx. 15 mm	approx. 25 mm	approx. 35 mm
Resolution	static ¹⁾	< 12 nm	< 36 nm	< 80 nm
	dynamic ²⁾	< 50 nm	< 125 nm	< 250 nm
Measuring rate		continuously adjustable from 100 Hz to 8 kHz		
Linearity ³⁾	Displacement and distance	< ±0.5 μm	< ±1.5 μm	< ±3.0 μm
	Thickness	< ±1.0 μm	< ±3.0 μm	< ±6.0 μm
Light source		internal white LED		
Permissible ambient light		30,000 lx		
Light spot diameter ⁴⁾		12 μm	18 μm	24 μm
Measuring angle ⁵⁾		±25°	±19°	±10°
Numerical aperture (NA)		0.45	0.35	0.18
Min. target thickness		0.05 mm	0.15 mm	0.3 mm
Target material		Reflective, diffuse as well as transparent surfaces (e.g. glass)		
Supply voltage		24 VDC ± 10 %		
Power consumption		< 5 W (24 V)		
Signal input		2 x encoders (A+, A-, B+, B-, index); 3 x encoders (A+, A-, B+, B-) 2x HTL/TTL multifunction inputs: trigger in, slave in, zero setting, mastering, teach; 1x RS422 synchronization input: trigger in, sync in, master/slave, master/slave alternating		
Digital interface ⁶⁾		EtherCAT / PROFINET / EtherNet/IP / RS422		
Analog output		4 ... 20 mA / 0 ... 5 V / 0 ... 10 V (16 bit D/A converter)		
Switching output		Error1-Out, Error2-Out		
Digital output		sync out		
Connection		12-pin M12 connector for supply, encoder, EtherCAT, PROFINET, EtherNet/IP, RS422 and Sync 17-pin M12 plug for I/O analog and encoder optional extension to 3 m / 6 m / 9 m / 15 m (see accessories for suitable connection cables)		
Installation		radial clamping, threaded hole, mounting adapter (see accessories)		
Temperature range	Storage	-20 ... +70 °C		
	Operation	+5 ... +50 °C		
Shock (DIN EN 60068-2-27)		15g / 6 ms in XY axis, 1000 shocks each		
Vibration (DIN EN 60068-2-6)		2g / 20 ... 500 Hz in XY axis, 10 cycles each		
Protection class (DIN EN 60529)	Sensor	IP64 (front)		
	Controller	IP65		
Material		Aluminum housing, passive cooling		
Weight		490 g	490 g	490 g
Control and indicator elements		Correct button: interfaces selection, two adjustable functions and reset to factory settings after 10 s; 4x color LEDs for Intensity, Range, RUN and ERR		

All data at constant ambient temperature (24 ± 2 °C)

¹⁾ Average from 512 values at 1 kHz, in the mid of the measuring range onto optical flat

²⁾ RMS noise relates to mid of measuring range (1 kHz)

³⁾ Maximum deviation from reference system over the entire measuring range, measured on front surface of ND filter







⁴⁾ In the mid of the measuring range

⁵⁾ Maximum sensor tilt angle that produces a usable signal on polished glass (n = 1.5) in the mid of the measuring range. The accuracy decreases when approaching the limit values.

⁶⁾ The controller can also be parameterized via Ethernet

High performance sensor system with integrated controller

confocalDT IFD2415

-  All-in-One: sensor and controller in one compact housing (IP65)
-  Adjustable measuring rate up to 25 kHz
- INTER**
FACE  EtherCAT / PROFINET / EtherNet/IP / RS422 / Analog
-  Micron-precise measurement of distance and thickness
-  High precision distance and thickness measurements (5 layers)
-  Short exposure time due to high light intensity

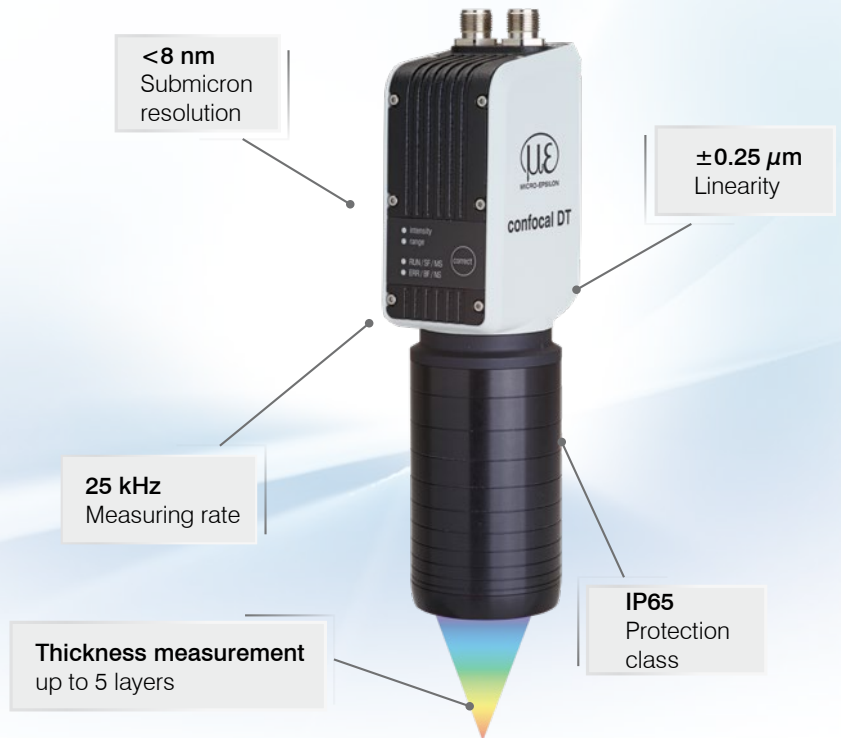

All-in-One: compact confocal sensor with high performance

The confocalDT IFD2415 is a powerful confocal sensor with integrated controller. The space-saving IP65-housing enables fast integration into plant equipment and machines as no optical fiber is required. Furthermore, the IFD2415 is ideally suited to high precision distance and thickness measurements in industrial series applications. In addition, the sensor can be used with transparent materials for multi-layer thickness measurements of up to 5 layers.

The active exposure time regulation of the CCD line enables fast and stable measurements of varying surfaces even in dynamic measurement processes up to 25 kHz. The measuring system is also characterized by high luminous intensity which enables fast and reliable measurements even on darker surfaces.

Intelligent technology meets high performance and user-friendliness

In Ethernet mode, the confocalDT IFD2415 can be set via the intuitive web interface. Industrial Ethernet ensures that the settings are automatically applied to the PLC environment. This eliminates time-consuming setting efforts in the programming environment.

Fast, precise and compact

The unique combination of sensor and controller combined with excellent performance and high measuring rate make the confocalDT IFD2415 the best in its class. This compact sensor can be used in series applications such as, e.g., in inline inspection machines, robots, 3D printers and coordinate measuring machines.

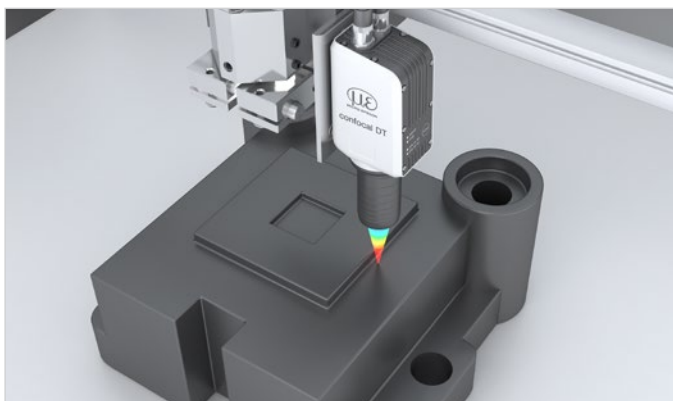

Displacement and distance measurement in 3D printing

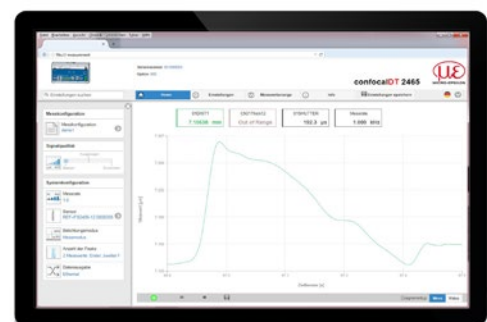

Simple parameter set up via integrated web interface

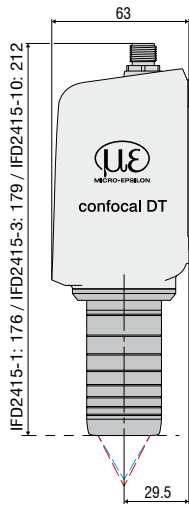

Dimensions in mm,
not to scale.

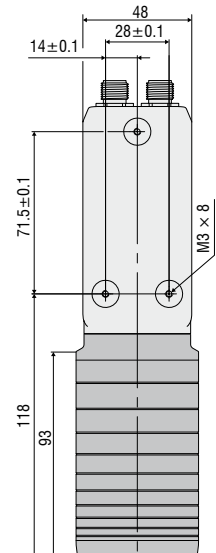
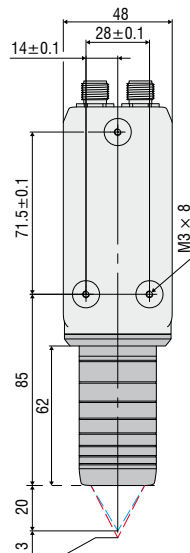
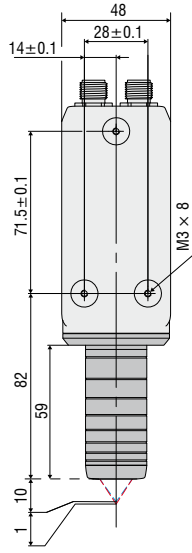

Model	IFD2415-1	IFD2415-3	IFD2415-10	
Measuring range	1.0 mm	3.0 mm	10.0 mm	
Start of measuring range	approx. 10 mm	approx. 20 mm	approx. 50 mm	
Resolution	static ¹⁾	< 8 nm	< 36 nm	
	dynamic ²⁾	< 38 nm	< 204 nm	
Measuring rate	continuously adjustable from 100 Hz to 25 kHz			
Linearity ³⁾	Displacement and distance	< ±0.25 μm	< ±0.75 μm	< ±2.5 μm
	Thickness	< ±0.5 μm	< ±1.5 μm	< ±5.0 μm
Light source	internal white LED			
Permissible ambient light	30,000 lx			
Light spot diameter ⁴⁾	8 μm	9 μm	16 μm	
Measuring angle ⁵⁾	±30°	±24°	±17°	
Numerical aperture (NA)	0.55	0.45	0.3	
Min. target thickness	0.05 mm	0.15 mm	0.5 mm	
Target material	Reflective, diffuse as well as transparent surfaces (e.g. glass)			
Supply voltage	24 VDC ± 10 %			
Power consumption	< 7W (24 V)			
Signal input	2x encoders (A+, A-, B+, B-, index); 3x encoders (A+, A-, B+, B-) 2x HTL/TTL multi-function inputs: trigger in, slave in, zero setting, mastering, teach-in; 1x RS422 synchronization input: trigger in, sync in, master/slave, master/slave alternating			
Digital interface ⁶⁾	EtherCAT / PROFINET / EtherNet/IP / RS422			
Analog output	4 ... 20 mA / 0 ... 5 V / 0 ... 10 V (16 bit D/A converter)			
Switching output	Error1-Out, Error2-Out			
Digital output	sync out			
Connection	12-pin M12 connector for supply, encoder, EtherCAT, PROFINET, EtherNet/IP, RS422 and Sync 17-pin M12 connector for I/O analog and encoder optional extension to 3 m / 6 m / 9 m / 15 m possible (see accessories for suitable connection cables)			
Installation	radial clamping, threaded hole, mounting adapter (see accessories)			
Temperature range	Storage	-20 ... +70 °C		
	Operation	+5 ... +50 °C		
Shock (DIN EN 60068-2-27)	15g / 6 ms in XY axis, 1000 shocks each			
Vibration (DIN EN 60068-2-6)	2g / 20 ... 500 Hz in XY axis, 10 cycles each			
Protection class (DIN EN 60529)	Sensor	IP64 (front)		
	Controller	IP65		
Material	Aluminum housing, passive cooling			
Weight	approx. 500 g	approx. 600 g	approx. 800 g	
Control and indicator elements	Correct button: interfaces selection, two adjustable functions and reset to factory settings after 10 s; 4x color LEDs for Intensity, Range, RUN and ERR			

All data at constant ambient temperature (24 ± 2 °C)

¹⁾ Average from 512 values at 1 kHz, in the mid of the measuring range onto optical flat

²⁾ RMS noise relates to mid of measuring range (1 kHz)

³⁾ Maximum deviation from reference system over the entire measuring range, measured on front surface of ND filter

⁴⁾ In the mid of the measuring range

⁵⁾ Maximum sensor tilt angle that produces a usable signal on polished glass (n = 1.5) in the mid of the measuring range. The accuracy decreases when approaching the limit values.

⁶⁾ The controller can also be parameterized via Ethernet

Compact confocal measuring system for industrial series applications

confocalDT IFD2411

- 12 nm Resolution**
- ±0.5 μm Linearity**
- IP40 Protection class**
- 8 kHz Measuring rate**
- Most compact confocal controller
- Excellent price/performance ratio
- IP40** Robust aluminum housing (IP40)
- Direct PLC connection due to Industrial Ethernet
- For precise distance and thickness measurements



Most compact design with highest performance and integrated Industrial Ethernet

The compact confocal IFD2411 measuring system is a factory-calibrated measuring system for industrial series applications. As well as displacement and distance measurements, the system enables even thickness measurements of transparent materials. The IFD2411 confocal chromatic measuring system is a complete channel which contains a controller and an adapted sensor with measuring ranges of 1 mm, 2 mm, 3 mm and 6 mm. Due to its favorable price/performance ratio, this measuring system is ideal for series applications.

Thanks to the integrated Industrial Ethernet interface, you integrate the controller directly into the PLC. In Ethernet mode, the controller can be set via the intuitive web interface. Industrial Ethernet ensures that the settings are automatically applied to the PLC environment. This eliminates time-consuming setting efforts in the programming environment.

Fast, precise and robust

With an adjustable measuring rate of up to 8 kHz and sub-micrometer resolution of up to 12 nm, the IFD2411 is suitable for numerous measurement tasks. The active exposure regulation of the CCD line enables fast and reliable measurements on varying surfaces.

Thanks to its extremely compact design and its robust IP40 aluminum housing, the controller of the IFD2411 measuring system can be integrated in almost all existing plants and systems. Integrated DIN rail mounting enables fast installation in the control cabinet.

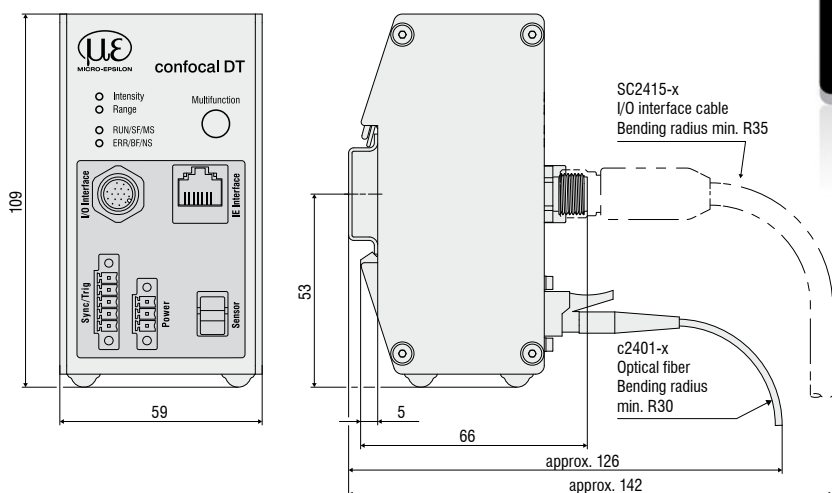

Simple parameter set up via integrated web interface

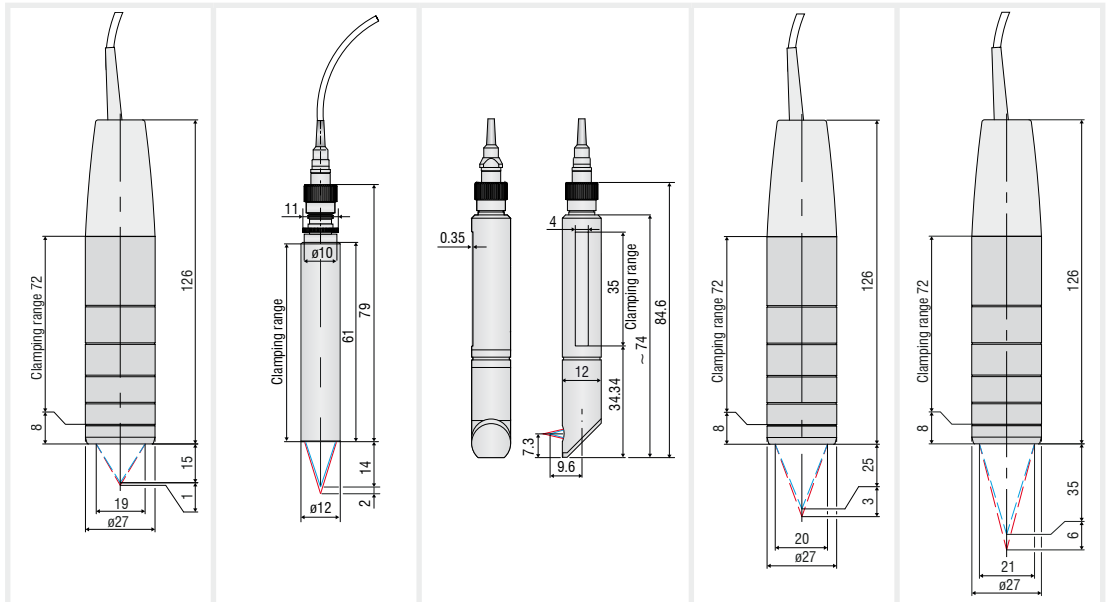

Model	IFD2411-1	IFD2411-2	IFD2411/90-2	IFD2411-3	IFD2411-6
Measuring range	1.0 mm		2.0 mm	3.0 mm	6.0 mm
Start of measuring range	approx. 15 mm	14 mm	9.6 mm ¹⁾	25 mm	35 mm
Resolution	static ²⁾ < 12 nm dynamic ³⁾ < 50 nm		< 40 nm < 125 nm	< 40 nm < 125 nm	< 80 nm < 250 nm
Measuring rate	continuously adjustable from 100 Hz to 8 kHz				
Linearity ⁴⁾	Distance < ±0.3 μm Thickness < ±0.6 μm		< ±0.6 μm < ±1.2 μm	< ±0.9 μm < ±1.8 μm	< ±1.8 μm < ±3.6 μm
Multi-peak measurement	1 layer				
Light source	internal white LED				
No. of characteristic curves	up to 10 characteristic curves for different sensors per channel, selection via table in the menu				
Permissible ambient light ⁵⁾	30,000 lx				
Light spot diameter	12 μm		10 μm	18 μm	24 μm
Max. measuring angle ⁶⁾	±25°		±12°	±19°	±10°
Numerical aperture (NA)	0.45		0.25	0.35	0.18
Min. target thickness ⁷⁾	0.05 mm		0.1 mm	0.15 mm	0.3 mm
Target material	reflective, diffuse as well as transparent surfaces (e.g. glass)				
Synchronization	yes				
Supply voltage	24 VDC ±10 %				
Power consumption	< 7 W (24V)				
Signal input	sync-in / trig-in; 1x encoder (A+, A-, B+, B-, index)				
Digital interface ⁸⁾	EtherCAT / PROFINET / EtherNet/IP / RS422				
Analog output	Current: 4 ... 20 mA; voltage: 0 ... 5V & 0 ... 10 V (16 bit D/A converter)				
Digital output	sync-out				
Connection	Optical	pluggable optical fiber via E2000 socket, length 2 m ... 50 m, min. bending radius 30 mm			
	Electrical	3-pin supply terminal strip; 5- or 6-pin I/O terminal strip (max. cable length 30 m); 17-pin M12 connector for RS422, analog and encoder; RJ45 socket for Ethernet (out) / EtherCAT / PROFINET / EtherNet/IP (in/out) (max. cable length 100 m)			
Installation	Free-standing, DIN rail mounting				
Temperature range	Storage	-20 ... +70 °C			
	Operation	Sensor: +5 ... +70 °C; controller: +5 ... +50 °C			
Shock (DIN EN 60068-2-27)	15g / 6 ms in XYZ axis, 1000 shocks each				
Vibration (DIN EN 60068-2-6)	2g / 20 ... 500 Hz in XYZ axis, 10 cycles each				
Protection class	Sensor	IP64			
(DIN EN 60529)	Controller	IP40			
Material	Aluminum				
Weight	Sensor	approx. 100 g	approx. 20 g	approx. 30 g	approx. 100 g
	Controller	approx. 335 g			
No. of measurement channels	1				
Control and indicator elements	Multifunction button: interfaces selection, two adjustable functions and reset to factory settings after 10 s; 4x color LEDs for Intensity, Range, RUN and ERR				

FSO = Full Scale Output

¹⁾ Start of measuring range measured from sensor axis

²⁾ Average from 512 values at 1 kHz, in the mid of the measuring range onto optical flat

³⁾ RMS noise relates to mid of measuring range (1 kHz)

⁴⁾ All data at constant ambient temperature (25±1 °C). Measurement on plane-parallel test glass. Acceptance report is enclosed with delivery.

⁵⁾ Illuminant: light bulb

⁶⁾ Maximum measuring angle of the sensor that produces a usable signal on reflecting surfaces. The accuracy decreases when approaching the limit values.





⁷⁾ Glass sheet with refractive index n = 1.5 in midrange

⁸⁾ The controller can also be parameterized via Ethernet

Confocal chromatic miniature sensors

confocalDT IFS2402



-  Miniature sensors Ø4 mm with axial or radial beam path
-  Submicron resolution
-  For precise distance measurements
-  Small light spot

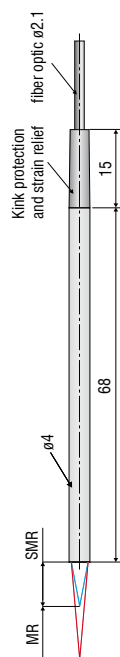

MR = Measuring range
SMR = Start of measuring range
Dimensions in mm, not to scale

Model		IFS2402-0.5	IFS2402-1,5	IFS2402-4
Measuring range		0.5 mm	1.5 mm	3.5 mm
Start of measuring range	approx.	1.7 mm	0.9 mm	1.9 mm
Resolution	static ¹⁾	16 nm	60 nm	100 nm
	dynamic ²⁾	48 nm	192 nm	480 nm
Linearity ³⁾	Displacement and distance	< ±0.2 μm	< ±1.2 μm	< ±3 μm
Light spot diameter		10 μm	20 μm	20 μm
Max. measuring angle ⁴⁾		±18°	±5°	±3°
Numerical aperture (NA)		0.40	0.20	0.10
Target material		reflective, diffuse as well as transparent surfaces (e.g. glass) ⁵⁾		
Connection		integrated optical fiber 2 m with E2000/APC connector; extension up to 50 m; bending radius: static 30 mm; dynamic 40 mm		
Installation		Clamping (mounting adapter see accessories)		
Temperature range	Storage	-20 ... +70 °C		
	Operation	+5 ... +70 °C		
Shock (DIN EN 60068-2-27)		15g / 6 ms in XY axis, 1000 shocks each		
Vibration (DIN EN 60068-2-6)		2g / 20 ... 500 Hz in XY axis, 10 cycles each		
Protection class (DIN EN 60529)		IP64 (front)		
Material		Stainless steel housing, glass lenses		
Weight		approx. 186 g (incl. optical fiber)		

¹⁾ Average from 512 values at 1 kHz, in the mid of the measuring range onto optical flat

²⁾ RMS noise relates to mid of measuring range (1 kHz)

³⁾ All data at constant ambient temperature (25±1 °C). Measurement on plane-parallel test glass. Acceptance report is enclosed with delivery.

⁴⁾ Maximum measuring angle of the sensor that produces a usable signal on reflecting surfaces. The accuracy decreases when approaching the limit values.

⁵⁾ No thickness measurement possible Distance measurement only possible if thickness of glass > measuring range. Measurements on metal only possible to a limited extent.

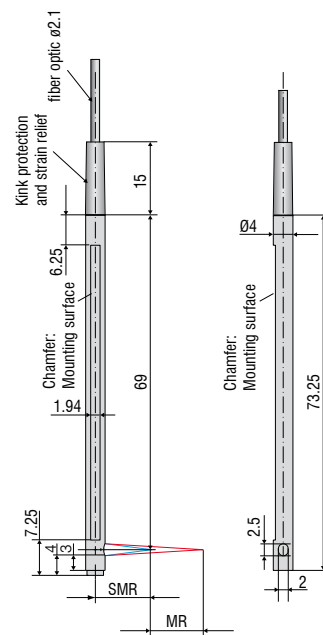

MR = Measuring range
 SMR = Start of measuring range
 Dimensions in mm, not to scale

Model		IFS2402/90-1,5	IFS2402/90-4
Measuring range		1.5 mm	2.5 mm
Start of measuring range	approx.	2.5 mm ¹⁾	2.5 mm ¹⁾
Resolution	static ²⁾	60 nm	100 nm
	dynamic ³⁾	192 nm	480 nm
Linearity ⁴⁾	Displacement and distance	< ±1.2 μm	< ±3 μm
Light spot diameter		20 μm	20 μm
Max. measuring angle ⁵⁾		±5°	±3°
Numerical aperture		0.20	0.10
Target material		reflective, diffuse as well as transparent surfaces (e.g. glass) ⁶⁾	
Connection		integrated optical fiber 2 m with E2000/APC connector; extension up to 50 m; bending radius: static 30 mm, dynamic 40 mm	
Installation		Clamping (mounting adapter see accessories)	
Temperature range	Storage	-20 ... +70 °C	
	Operation	+5 ... +70 °C	
Shock (DIN EN 60068-2-27)		15g / 6 ms in XY axis, 1000 shocks each	
Vibration (DIN EN 60068-2-6)		2g / 20 ... 500 Hz in XY axis, 10 cycles each	
Protection class (DIN EN 60529)		IP40	
Material		Stainless steel housing, glass lenses	
Weight		approx. 186 g (incl. optical fiber)	

¹⁾ Start of measuring range measured from sensor axis

²⁾ Average from 512 values at 1 kHz, in the mid of the measuring range onto optical flat

³⁾ RMS noise relates to mid of measuring range (1 kHz)

⁴⁾ All data at constant ambient temperature (25±1 °C). Measurement on plane-parallel test glass. Acceptance report is enclosed with delivery.





⁵⁾ Maximum measuring angle of the sensor that produces a usable signal on reflecting surfaces. The accuracy decreases when approaching the limit values.

⁶⁾ No thickness measurement possible Distance measurement only possible if thickness of glass > measuring range. Measurements on metal only possible to a limited extent.

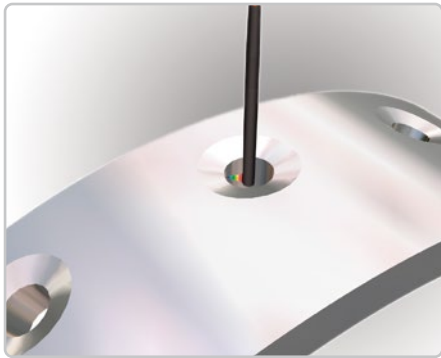
Confocal chromatic hybrid sensors

confocalDT IFS2403



-  Hybrid sensors $\varnothing 8$ mm with axial or radial beam path
-  Submicron resolution
-  For one-sided thickness measurements
-  For precise distance measurements
-  Small light spot

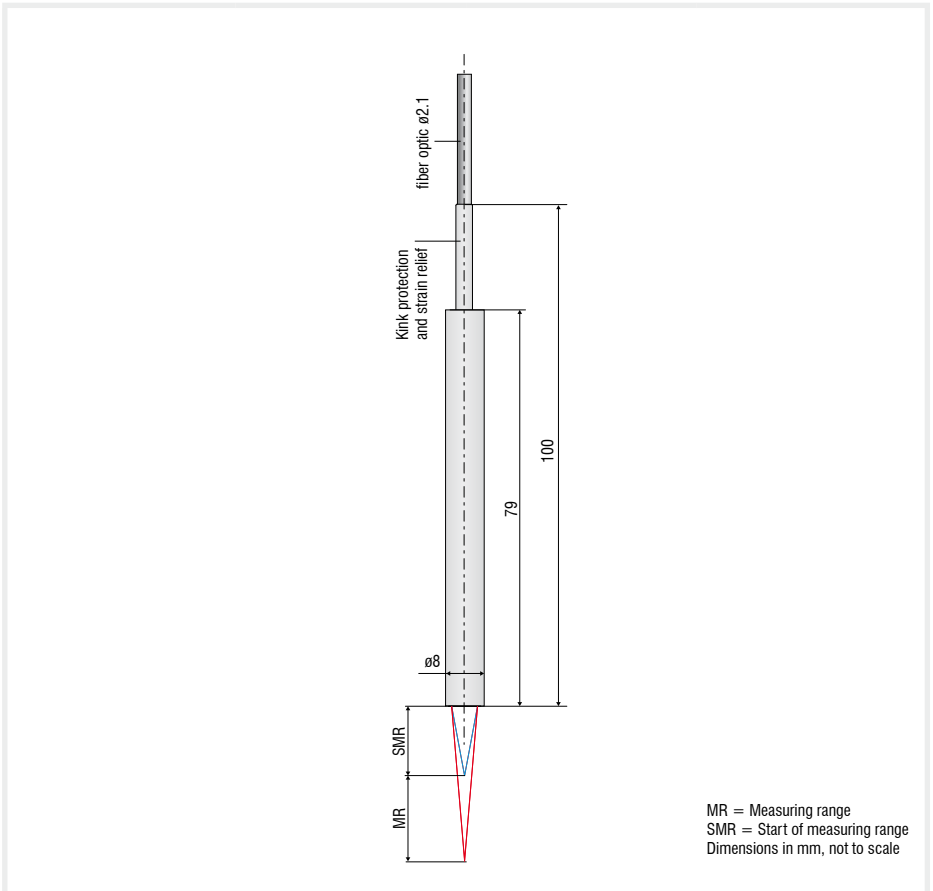

Model		IFS2403-0.4	IFS2403-1.5	IFS2403-4	IFS2403-10
Measuring range		0.4 mm	1.5 mm	4 mm	10 mm
Start of measuring range	approx.	2.5 mm	8 mm	14.7 mm	11 mm
Resolution	static ¹⁾	16 nm	60 nm	100 nm	250 nm
	dynamic ²⁾	47 nm	186 nm	460 nm	1250 nm
Linearity ³⁾	Displacement and distance	< $\pm 0.3 \mu\text{m}$	< $\pm 1.2 \mu\text{m}$	< $\pm 3 \mu\text{m}$	< $\pm 8 \mu\text{m}$
	Thickness	< $\pm 0.6 \mu\text{m}$	< $\pm 2.4 \mu\text{m}$	< $\pm 6 \mu\text{m}$	< $\pm 16 \mu\text{m}$
Light spot diameter		9 μm	15 μm	28 μm	56 μm
Max. measuring angle ⁴⁾		$\pm 20^\circ$	$\pm 16^\circ$	$\pm 6^\circ$	$\pm 6^\circ$
Numerical aperture (NA)		0.50	0.30	0.15	0.15
Min. target thickness ⁵⁾		0.06 mm	0.23 mm	0.6 mm	1.5 mm
Target material		reflective, diffuse as well as transparent surfaces (e.g. glass)			
Connection		integrated optical fiber 2 m with E2000/APC connector; extension up to 50 m; bending radius: static 30 mm, dynamic 40 mm			
Installation		Clamping (mounting adapter see accessories)			
Temperature range	Storage	-20 ... +70 °C			
	Operation	+5 ... +70 °C			
Shock (DIN EN 60068-2-27)		15g / 6 ms in XY axis, 1000 shocks each			
Vibration (DIN EN 60068-2-6)		2g / 20 ... 500 Hz in XY axis, 10 cycles each			
Protection class (DIN EN 60529)		IP64 (front)			
Material		Stainless steel housing, glass lenses			
Weight		approx. 200 g (incl. optical fiber)			

¹⁾ Average from 512 values at 1 kHz, in the mid of the measuring range onto optical flat

²⁾ RMS noise relates to mid of measuring range (1 kHz)

³⁾ All data at constant ambient temperature (25 \pm 1 °C). Measurement on plane-parallel test glass. Acceptance report is enclosed with delivery.

⁴⁾ Maximum measuring angle of the sensor that produces a usable signal on reflecting surfaces. The accuracy decreases when approaching the limit values.

⁵⁾ Glass sheet with refractive index n = 1.5 in midrange

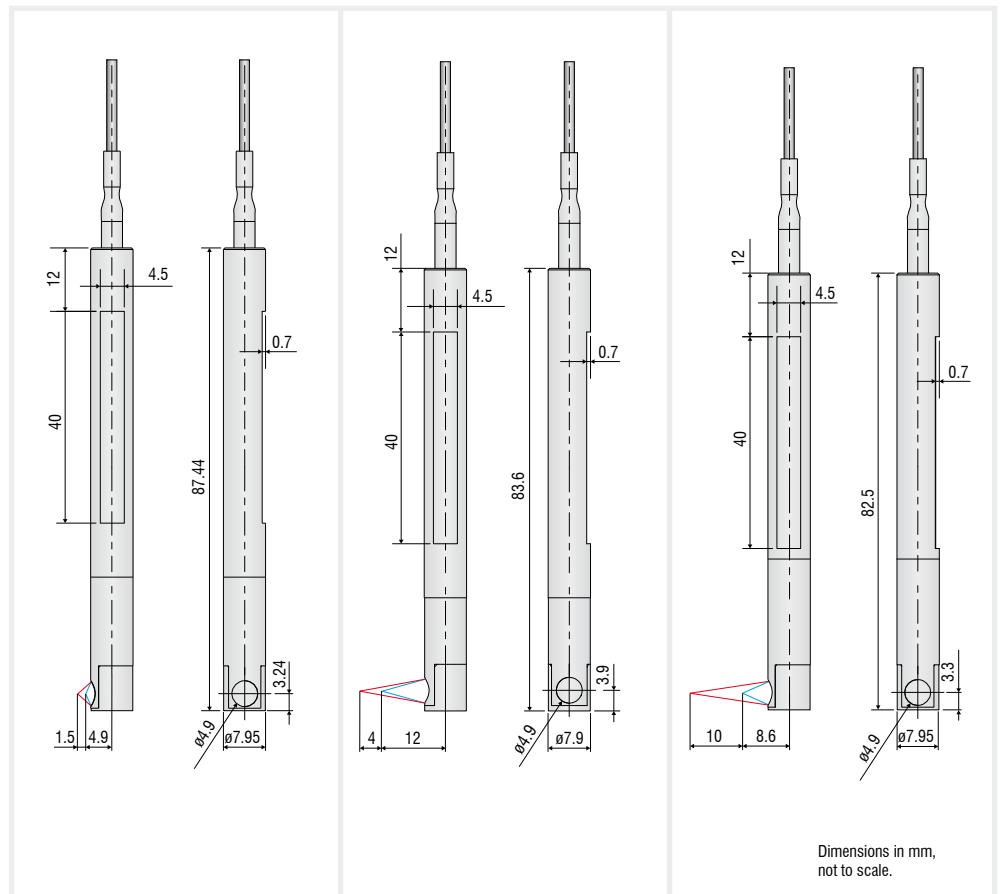

Dimensions in mm,
not to scale.

Model	IFS2403/90-1.5	IFS2403/90-4	IFS2403/90-10
Measuring range	1.5 mm	4 mm	10 mm
Start of measuring range	approx. 4.9 mm ¹⁾	12 mm ¹⁾	8.6 mm ¹⁾
Resolution	static ²⁾ 60 nm	100 nm	250 nm
	dynamic ³⁾ 186 nm	460 nm	1250 nm
Linearity ⁴⁾	Displacement and distance < $\pm 1.2 \mu\text{m}$	< $\pm 3 \mu\text{m}$	< $\pm 8 \mu\text{m}$
	Thickness < $\pm 2.4 \mu\text{m}$	< $\pm 6 \mu\text{m}$	< $\pm 16 \mu\text{m}$
Light spot diameter	15 μm	28 μm	56 μm
Max. measuring angle ⁵⁾	$\pm 16^\circ$	$\pm 6^\circ$	$\pm 6^\circ$
Numerical aperture (NA)	0.30	0.15	0.15
Min. target thickness ⁶⁾	0.23 mm	0.6 mm	1.5 mm
Target material	reflective, diffuse as well as transparent surfaces (e.g. glass)		
Connection	integrated optical fiber 2 m with E2000/APC connector; extension up to 50 m; bending radius: static 30 mm, dynamic 40 mm		
Installation	Clamping (mounting adapter see accessories)		
Temperature range	Storage -20 ... +70 °C	-20 ... +70 °C	
	Operation +5 ... +70 °C	+5 ... +70 °C	
Shock (DIN EN 60068-2-27)	15g / 6 ms in XY axis, 1000 shocks each		
Vibration (DIN EN 60068-2-6)	2g / 20 ... 500 Hz in XY axis, 10 cycles each		
Protection class (DIN EN 60529)	IP64 (front)		
Material	Stainless steel housing, glass lenses		
Weight	approx. 200 g (incl. optical fiber)		

¹⁾ Start of measuring range measured from sensor axis

²⁾ Average from 512 values at 1 kHz, in the mid of the measuring range onto optical flat

³⁾ RMS noise relates to mid of measuring range (1 kHz)

⁴⁾ All data at constant ambient temperature (25 \pm 1 °C). Measurement on plane-parallel test glass. Acceptance report is enclosed with delivery.





⁵⁾ Maximum measuring angle of the sensor that produces a usable signal on reflecting surfaces. The accuracy decreases when approaching the limit values.

⁶⁾ Glass sheet with refractive index n = 1.5 in midrange

Confocal chromatic sensors

confocalDT IFS2404



-  Compact sensors $\varnothing 12$ mm
-  Submicron resolution
-  For one-sided thickness measurements
-  For precise distance measurements
-  Small light spot

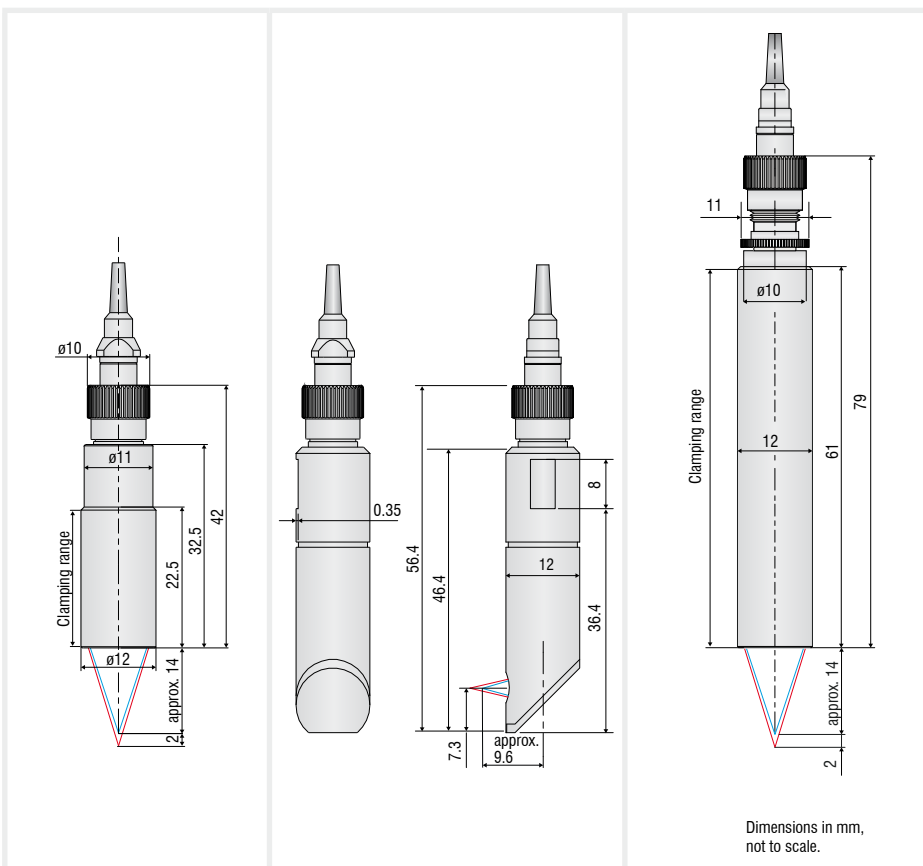

Model	IFS2404-2	IFS2404/90-2	IFS2404-2(001)
Measuring range	2 mm	2 mm	2 mm
Start of measuring range	approx. 14 mm	9.6 mm ¹⁾	14 mm
Resolution	static ²⁾	40 nm	40 nm
	dynamic ³⁾	125 nm	125 nm
Linearity ⁴⁾	Displacement and distance	< $\pm 0.6 \mu\text{m}$	< $\pm 0.6 \mu\text{m}$
	Thickness	< $\pm 1.2 \mu\text{m}$	< $\pm 1.2 \mu\text{m}$
Light spot diameter	10 μm	10 μm	10 μm
Max. tilt angle ⁵⁾	$\pm 12^\circ$	$\pm 12^\circ$	$\pm 12^\circ$
Numerical aperture (NA)	0.25	0.25	0.25
Min. target thickness ⁶⁾	0.1 mm	0.1 mm	0.1 mm
Target material	reflective, diffuse as well as transparent surfaces (e.g. glass)		
Connection	pluggable optical fiber via FC socket, type C2404; standard length 2 m; extension up to 50 m; bending radius: static 30 mm, dynamic 40 mm		pluggable optical fiber via FC socket, standard length 3 m; extension up to 50 m; bending radius: static 30 mm, dynamic 40 mm
Installation	Clamping (mounting adapter see accessories)		
Temperature range	Storage	-20 ... +70 °C	
	Operation	+5 ... +70 °C	
Shock (DIN EN 60068-2-27)	15g / 6 ms in XY axis, 1000 shocks each		
Vibration (DIN EN 60068-2-6)	2g / 20 ... 500 Hz in XY axis, 10 cycles each		
Protection class (DIN EN 60529)	IP65 (front)		
Material	Stainless steel housing, glass lenses		
Weight ⁷⁾	approx. 20 g	approx. 30 g	approx. 40 g

¹⁾ Start of measuring range measured from sensor axis

²⁾ Average from 512 values at 1 kHz, in the mid of the measuring range onto optical flat

³⁾ RMS noise relates to mid of measuring range (1 kHz)

⁴⁾ All data at constant ambient temperature (25 ± 1 °C). Measurement on plane-parallel test glass. Acceptance report is enclosed with delivery.

⁵⁾ Maximum measuring angle of the sensor that produces a usable signal on reflecting surfaces. The accuracy decreases when approaching the limit values.





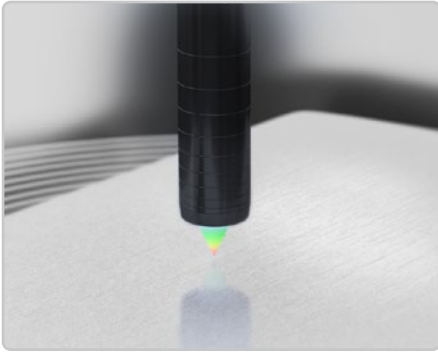

⁶⁾ Glass sheet with refractive index $n = 1.5$ throughout the entire measuring range. In the mid of the measuring range, also thinner layers can be measured.

⁷⁾ Sensor weight without optical fiber

Confocal sensors with high precision

confocalDT IFS2405



-  Robust universal sensors for various applications
-  Submicron resolution
-  For one-sided thickness measurements
-  For precise distance measurements
-  Very small light spot
-  Large tilt angle

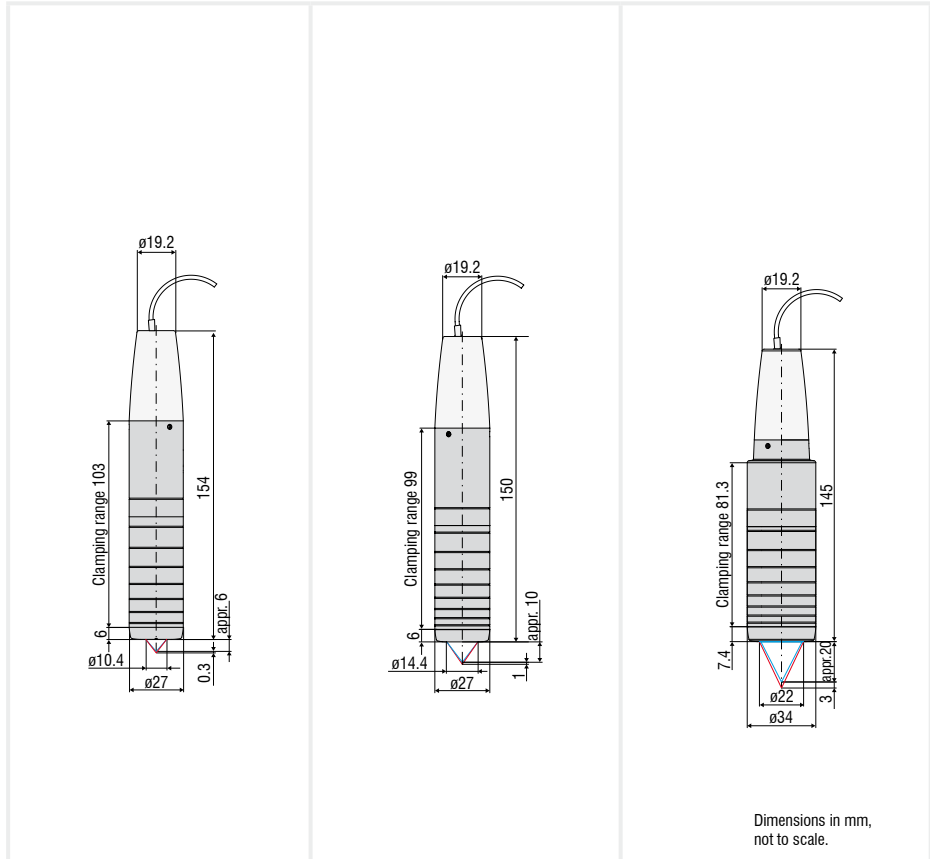

Dimensions in mm, not to scale.

Model	IFS2405-0.3	IFS2405-1	IFS2405-3
Measuring range	0.3 mm	1 mm	3 mm
Start of measuring range	approx. 6 mm	10 mm	20 mm
Resolution	static ¹⁾	4 nm	8 nm
	dynamic ²⁾	18 nm	38 nm
Linearity ³⁾	Displacement and distance	< ±0.1 μm	< ±0.25 μm
	Thickness	< ±0.2 μm	< ±0.5 μm
Light spot diameter	6 μm	8 μm	9 μm
Max. measuring angle ⁴⁾	±34°	±30°	±24°
Numerical aperture (NA)	0.60	0.55	0.45
Min. target thickness ⁵⁾	0.015 mm	0.05 mm	0.15 mm
Target material	reflective, diffuse as well as transparent surfaces (e.g. glass)		
Connection	pluggable optical fiber via FC socket, standard length 3 m; extension up to 50 m; bending radius: static 30 mm; dynamic 40 mm		
Installation	Clamping (mounting adapter see accessories)		
Temperature range	Storage	-20 ... +70 °C	
	Operation	+5 ... +70 °C	
Shock (DIN EN 60068-2-27)	15g / 6 ms in XY axis, 1000 shocks each		
Vibration (DIN EN 60068-2-6)	2g / 20 ... 500 Hz in XY axis, 10 cycles each		
Protection class (DIN EN 60529)	IP64 (front)		
Material	Aluminum housing, glass lenses		
Weight ⁶⁾	approx. 140 g	approx. 125 g	approx. 225 g

¹⁾ Average from 512 values at 1 kHz, in the mid of the measuring range onto optical flat

²⁾ RMS noise relates to mid of measuring range (1 kHz)

³⁾ All data at constant ambient temperature (25±1 °C). Measurement on plane-parallel test glass. Acceptance report is enclosed with delivery.

⁴⁾ Maximum measuring angle of the sensor that produces a usable signal on reflecting surfaces. The accuracy decreases when approaching the limit values.





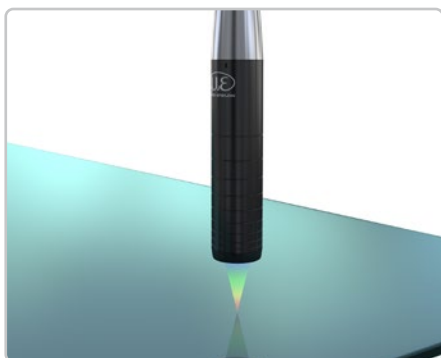

⁵⁾ Glass sheet with refractive index n = 1.5 throughout the entire measuring range. In the mid of the measuring range, also thinner layers can be measured.

⁶⁾ Sensor weight without optical fiber

Confocal sensors with high precision

confocalDT IFS2405



-  Robust universal sensors for various applications
-  Submicron resolution
-  For one-sided thickness measurements
-  For precise distance measurements
-  Very small light spot
-  Large tilt angle

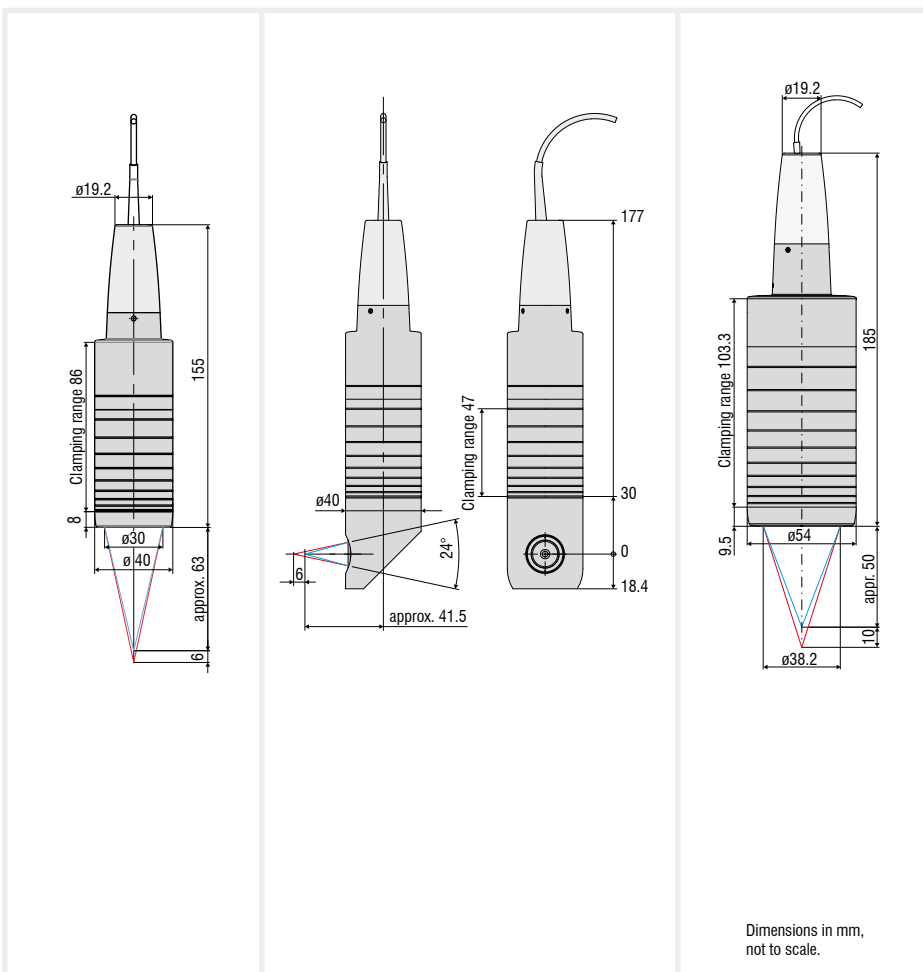

Model	IFS2405-6	IFS2405/90-6	IFS2405-10
Measuring range	6 mm	6 mm	10 mm
Start of measuring range	approx. 63 mm	41 mm ¹⁾	50 mm
Resolution	static ²⁾	34 nm	36 nm
	dynamic ³⁾	190 nm	204 nm
Linearity ⁴⁾	Displacement and distance	< ±1.5 μm	< ±1.5 μm
	Thickness	< ±3 μm	< ±3 μm
Light spot diameter	31 μm	31 μm	16 μm
Max. measuring angle ⁵⁾	±10°	±10°	±17°
Numerical aperture (NA)	0.22	0.22	0.30
Min. target thickness ⁶⁾	0.3 mm	0.3 mm	0.5 mm
Target material	reflective, diffuse as well as transparent surfaces (e.g. glass)		
Connection	pluggable optical fiber via FC socket, standard length 3 m; extension up to 50 m; bending radius: static 30 mm; dynamic 40 mm		
Installation	Clamping (mounting adapter see accessories)		
Temperature range	Storage	-20 ... +70 °C	
	Operation	+5 ... +70 °C	
Shock (DIN EN 60068-2-27)	15g / 6 ms in XY axis, 1000 shocks each		
Vibration (DIN EN 60068-2-6)	2g / 20 ... 500 Hz in XY axis, 10 cycles each		
Protection class (DIN EN 60529)	IP64 (front)		
Material	Aluminum housing, glass lenses		
Weight ⁷⁾	approx. 260 g	approx. 315 g	approx. 500 g

¹⁾ Start of measuring range measured from sensor axis

²⁾ Average from 512 values at 1 kHz, in the mid of the measuring range onto optical flat

³⁾ RMS noise relates to mid of measuring range (1 kHz)

⁴⁾ All data at constant ambient temperature (25 ± 1 °C). Measurement on plane-parallel test glass. Acceptance report is enclosed with delivery.

⁵⁾ Maximum measuring angle of the sensor that produces a usable signal on reflecting surfaces. The accuracy decreases when approaching the limit values.

⁶⁾ Glass sheet with refractive index n = 1.5 throughout the entire measuring range. In the mid of the measuring range, also thinner layers can be measured.

⁷⁾ Sensor weight without optical fiber

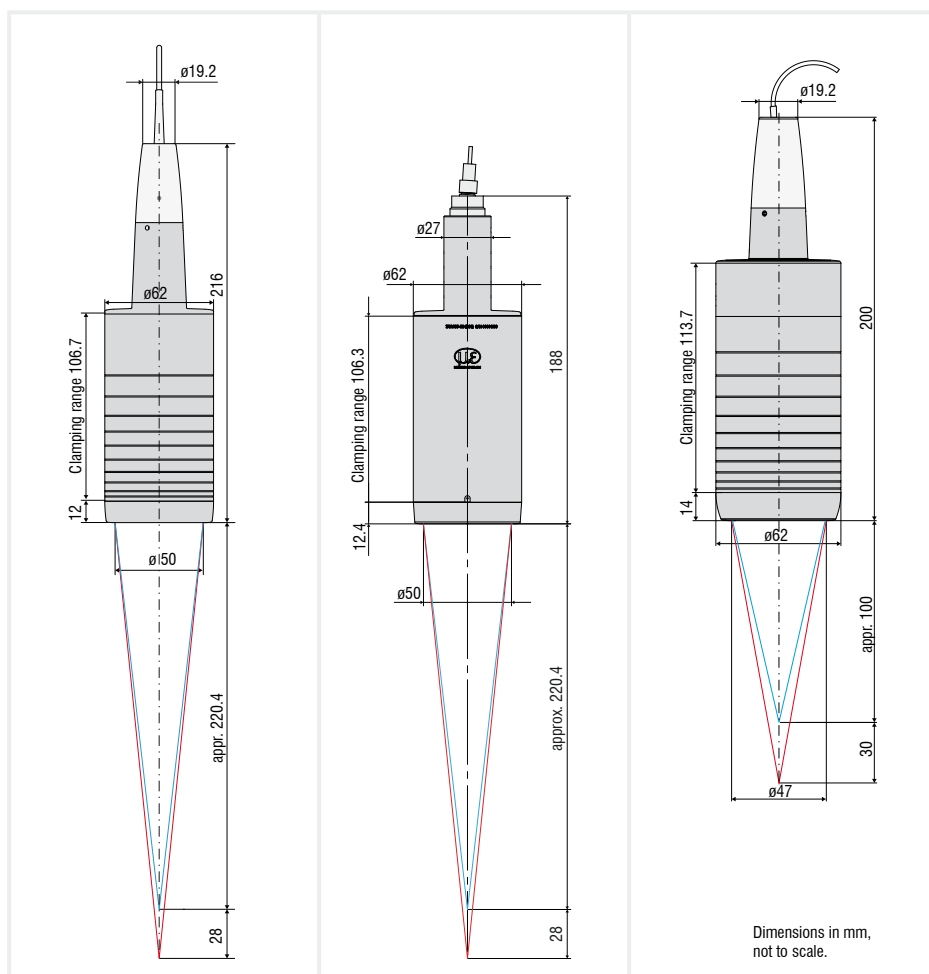

Model	IFS2405-28	IFS2405-28/VAC(001)	IFS2405-30
Measuring range		28 mm	30 mm
Start of measuring range	approx.	220 mm	100 mm
Resolution	static ¹⁾	130 nm	93 nm
	dynamic ²⁾	747 nm	530 nm
Linearity ³⁾	Displacement and distance	< ±7 μm	< ±6 μm
	Thickness	< ±14 μm	< ±12 μm
Light spot diameter		60 μm	50 μm
Max. measuring angle ⁴⁾		±5°	±9°
Numerical aperture (NA)		0.10	0.20
Min. target thickness ⁵⁾		2.2 mm	1.5 mm
Target material	reflective, diffuse as well as transparent surfaces (e.g. glass)		
Connection	pluggable optical fiber via FC socket, standard length 3 m; extension up to 50 m; bending radius: static 30 mm; dynamic 40 mm		
Installation	Clamping (mounting adapter see accessories)		
Temperature range	Storage	-20 ... +70 °C	
	Operation	+5 ... +70 °C	
Shock (DIN EN 60068-2-27)	15g / 6 ms in XY axis, 1000 shocks each		
Vibration (DIN EN 60068-2-6)	2g / 20 ... 500 Hz in XY axis, 10 cycles each		
Protection class (DIN EN 60529)	IP64 (front)	IP40 (vacuum compatible)	IP65 (front)
Material	Aluminum housing, glass lenses	Burnished stainless steel housing	Aluminum housing, glass lenses
Weight ⁶⁾	approx. 750 g		approx. 730 g

¹⁾ Average from 512 values at 1 kHz, in the mid of the measuring range onto optical flat

²⁾ RMS noise relates to mid of measuring range (1 kHz)

³⁾ All data at constant ambient temperature (25±1 °C). Measurement on plane-parallel test glass. Acceptance report is enclosed with delivery.

⁴⁾ Maximum measuring angle of the sensor that produces a usable signal on reflecting surfaces. The accuracy decreases when approaching the limit values.





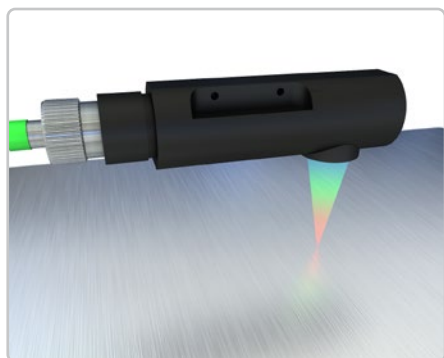

⁵⁾ Glass sheet with refractive index n = 1.5 throughout the entire measuring range. In the mid of the measuring range, also thinner layers can be measured.

⁶⁾ Sensor weight without optical fiber

Confocal chromatic sensors for displacement and thickness

confocalDT IFS2406



-  Sensors with axial or radial beam path
-  Submicron resolution
-  For one-sided thickness measurements
-  For precise distance measurements
-  Very small light spot
-  Suitable for VAC areas

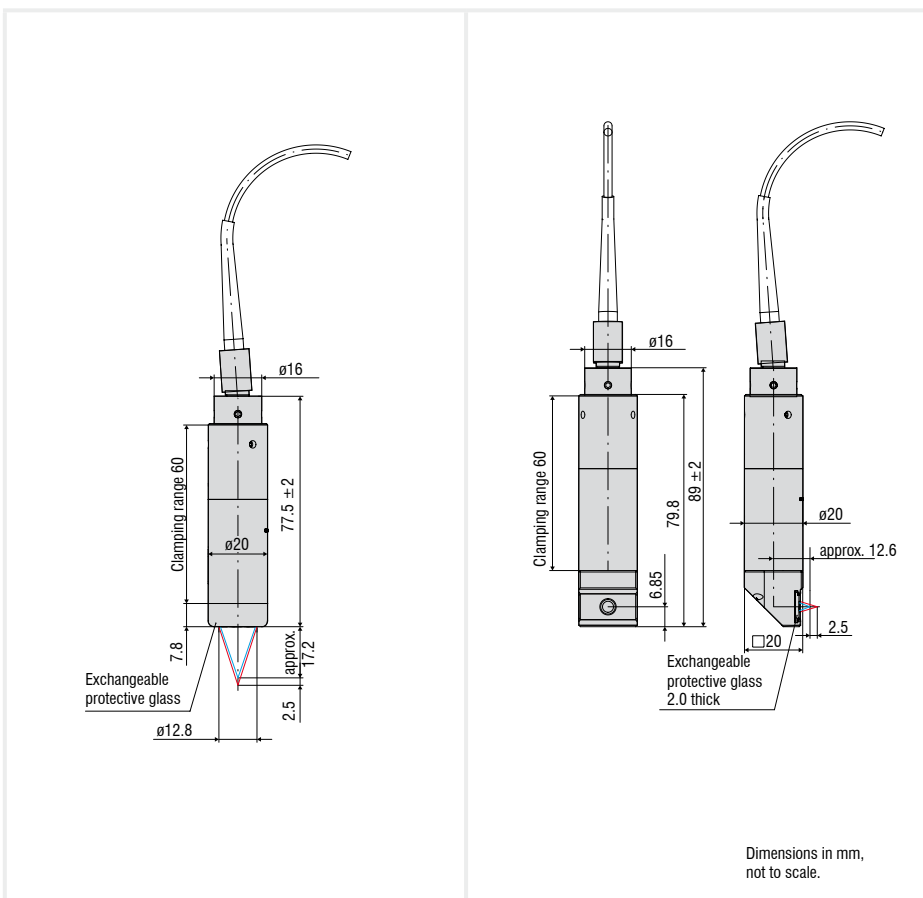

Dimensions in mm, not to scale.

Model		IFS2406-2,5/VAC(003)	IFS2406/90-2,5/VAC(001)
Measuring range		2.5 mm	2.5 mm
Start of measuring range	approx.	17.2 mm	12.6 mm ¹⁾
Resolution	static ²⁾	18 nm	18 nm
	dynamic ³⁾	97 nm	97 nm
Linearity ⁴⁾	Displacement and distance	< ±0.75 μm	< ±0.75 μm
	Thickness	< ±1.5 μm	< ±1.5 μm
Light spot diameter		10 μm	10 μm
Max. measuring angle ⁵⁾		±16°	±16°
Numerical aperture (NA)		0.30	0.30
Min. target thickness ⁶⁾		0.125 mm	0.125 mm
Target material		reflective, diffuse as well as transparent surfaces (e.g. glass)	
Connection		pluggable optical fiber via FC socket, type C240x-x (01); standard length 3 m; extension up to 50 m; bending radius: static 30 mm, dynamic 40 mm	
Installation		Clamping (mounting adapter see accessories)	
Temperature range	Storage	-20 ... +70 °C	
	Operation	+5 ... +70 °C	
Shock (DIN EN 60068-2-27)		15g / 6 ms in XY axis, 1000 shocks each	
Vibration (DIN EN 60068-2-6)		2g / 20 ... 500 Hz in XY axis, 10 cycles each	
Protection class (DIN EN 60529)		IP40 (vacuum compatible)	
Material		Stainless steel housing, glass lenses	
Weight ⁷⁾		approx. 105 g	approx. 130 g

¹⁾ Start of measuring range measured from sensor axis

²⁾ Average from 512 values at 1 kHz, in the mid of the measuring range onto optical flat

³⁾ RMS noise relates to mid of measuring range (1 kHz)

⁴⁾ All data at constant ambient temperature (25 ± 1 °C). Measurement on plane-parallel test glass. Acceptance report is enclosed with delivery.

⁵⁾ Maximum measuring angle of the sensor that produces a usable signal on reflecting surfaces. The accuracy decreases when approaching the limit values.

⁶⁾ Glass sheet with refractive index n = 1.5 throughout the entire measuring range. In the mid of the measuring range, also thinner layers can be measured.

⁷⁾ Sensor weight without optical fiber

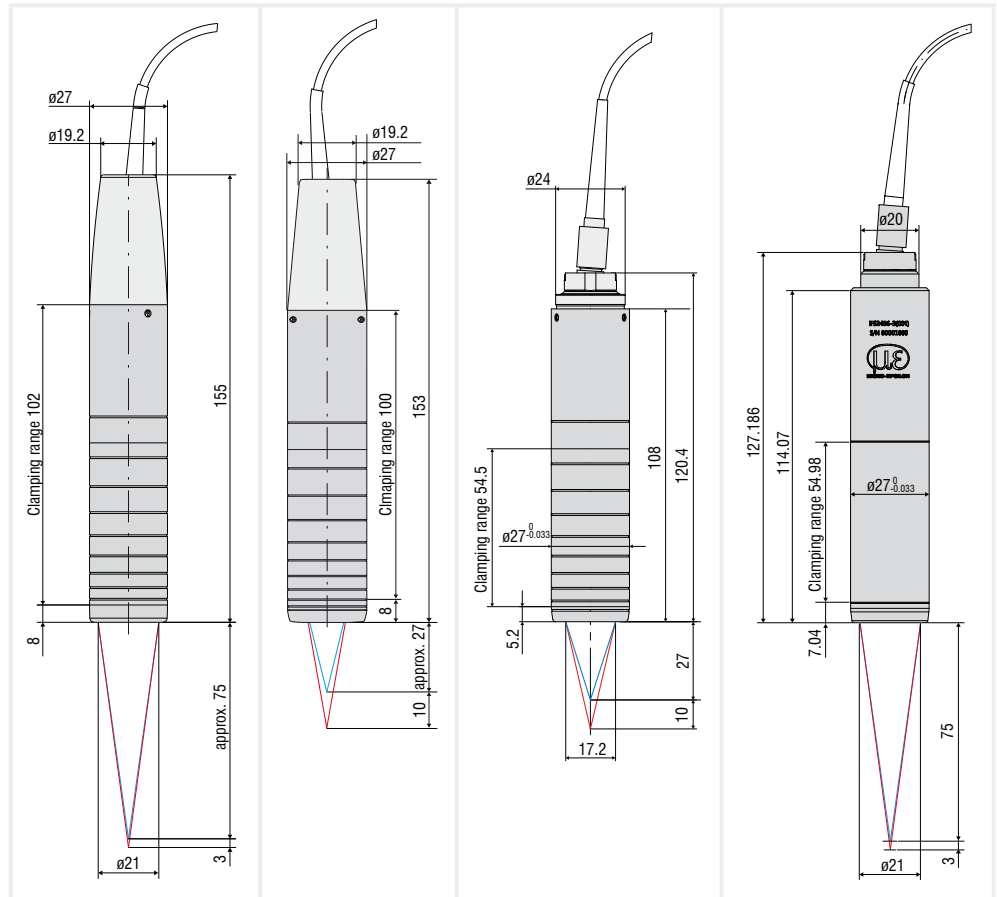

Dimensions in mm,
not to scale.

Model	IFS2406-3	IFS2406-10	IFS2406-10/VAC(001)	IFS2406-3/VAC(001)
Measuring range	3 mm		10 mm	3 mm
Start of measuring range	approx. 75 mm		27 mm	75 mm
Resolution	static ¹⁾	32 nm	38 nm	50 nm
	dynamic ²⁾	168 nm	207 nm	168 nm
Linearity ³⁾	Displacement and distance	< ±1.5 μm	< ±2 μm	< ±1.5 μm
	Thickness	< ±3 μm	< ±4 μm	< ±3 μm
Light spot diameter	35 μm		15 μm	35 μm
Max. measuring angle ⁴⁾	±6.5°		±13.5°	±6.5°
Numerical aperture (NA)	0.14		0.25	0.14
Min. target thickness ⁵⁾	0.15 mm		0.5 mm	0.15 mm
Target material	reflective, diffuse as well as transparent surfaces (e.g. glass)			
Connection	pluggable optical fiber via FC socket, type C240x-x (01); standard length 3 m; extension up to 50 m; bending radius: static 30 mm, dynamic 40 mm		pluggable optical fiber via FC socket, type C240x-x/VAC(01); standard length 3 m; extension up to 50 m; bending radius: static 30 mm, dynamic 40 mm	
Installation	Clamping (mounting adapter see accessories)			
Temperature range	Storage	-20 ... +70 °C		
	Operation	+5 ... +70 °C		
Shock (DIN EN 60068-2-27)	15g / 6 ms in XY axis, 1000 shocks each			
Vibration (DIN EN 60068-2-6)	2g / 20 ... 500 Hz in XY axis, 10 cycles each			
Protection class (DIN EN 60529)	IP65 (front)		IP40 (vacuum compatible)	IP40 (vacuum compatible)
Material	Aluminum housing, glass lenses		Stainless steel housing, anodized aluminum housing	Stainless steel housing (1.4305), glass lenses
Weight ⁶⁾	approx. 99 g		approx. 128 g	approx. 250 g

¹⁾ Average from 512 values at 1 kHz, in the mid of the measuring range onto optical flat

²⁾ RMS noise relates to mid of measuring range (1 kHz)

³⁾ All data at constant ambient temperature (25±1 °C). Measurement on plane-parallel test glass. Acceptance report is enclosed with delivery.

⁴⁾ Maximum measuring angle of the sensor that produces a usable signal on reflecting surfaces. The accuracy decreases when approaching the limit values.





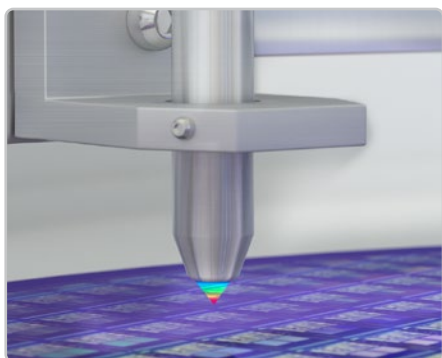

⁵⁾ Glass sheet with refractive index n = 1.5 throughout the entire measuring range. In the mid of the measuring range, also thinner layers can be measured.

⁶⁾ Sensor weight without optical fiber

High precision sensors for displacement and thickness measurements

confocalDT IFS2407



-  Compact sensors from $\varnothing 12$ mm
-  Submicron resolution
-  For one-sided thickness measurements
-  For precise distance measurements
-  Very small light spot
-  Large tilt angle

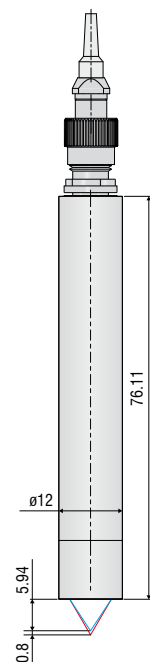
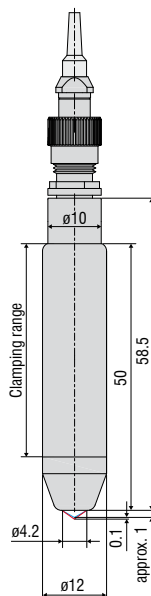

Dimensions in mm, not to scale.

Model	IFS2407-0.1	IFS2407-0.1(001)	IFS2407-0.8
Measuring range	0.1 mm	0.1 mm	0.8 mm
Start of measuring range	approx. 1 mm	1 mm	5.9 mm
Resolution	static ¹⁾	3 nm	24 nm
	dynamic ²⁾	6 nm	75 nm
Linearity ³⁾	Displacement and distance	< $\pm 0.05 \mu\text{m}$	< $\pm 0.2 \mu\text{m}$
	Thickness	< $\pm 0.1 \mu\text{m}$	< $\pm 0.4 \mu\text{m}$
Light spot diameter	3 μm	4 μm	6 μm
Max. measuring angle ⁴⁾	$\pm 48^\circ$	$\pm 48^\circ$	$\pm 30^\circ$
Numerical aperture (NA)	0.80	0.70	0.50
Min. target thickness ⁵⁾	0.005 mm	0.005 mm	0.04 mm
Target material	reflective, diffuse as well as transparent surfaces (e.g. glass)		
Connection	pluggable optical fiber via FC socket, standard length 3 m; extension up to 50 m; bending radius: static 30 mm; dynamic 40 mm		
Installation	Clamping (mounting adapter see accessories)		
Temperature range	Storage	-20 ... +70 °C	
	Operation	+5 ... +70 °C	
Shock (DIN EN 60068-2-27)	15g / 6 ms in XY axis, 1000 shocks each		
Vibration (DIN EN 60068-2-6)	2g / 20 ... 500 Hz in XY axis, 10 cycles each		
Protection class (DIN EN 60529)	IP65 (front)		
Material	Stainless steel housing, glass lenses		
Weight ⁶⁾	approx. 36 g	approx. 36 g	approx. 40 g
Special features	Sensor with high numerical aperture	Light-intensive sensor	-

¹⁾ Average from 512 values at 1 kHz, in the mid of the measuring range onto optical flat

²⁾ RMS noise relates to mid of measuring range (1 kHz)

³⁾ All data at constant ambient temperature (25 ± 1 °C). Measurement on plane-parallel test glass. Acceptance report is enclosed with delivery.









⁴⁾ Maximum measuring angle of the sensor that produces a usable signal on reflecting surfaces. The accuracy decreases when approaching the limit values.

⁵⁾ Glass sheet with refractive index $n = 1.5$ throughout the entire measuring range. In the mid of the measuring range, also thinner layers can be measured.

⁶⁾ Sensor weight without optical fiber

The new confocal controller for industrial applications

confocalDT IFC242x

-  Measuring rate up to 10 kHz
-  **INTERFACE** Ethernet / EtherCAT / RS422 / PROFINET / EtherNet/IP / Analog
-  Fast surface compensation
-  Configuration via web interface
-  Submicron resolution
-  Thickness measurement of multi-layer materials
-  Synchronous two-sided thickness measurement
-  Robust design with passive cooling



The confocalDT 2421/22 controllers set the industrial standard in precise, confocal measurement technology. Available as either a single- or a dual-channel version, these measuring systems are a low cost solution especially for serial applications. The active exposure regulation of the CCD line enables fast and accurate compensation of varying surfaces.

The controller can be operated with any IFS sensor and is available as a standard version for distance and thickness measurements or as a multi-peak version for multi-layer measurements. Using a special calculation function, the confocalDT 2422 dual-channel version evaluates both channels. Measurement acquisition is synchronous and can be carried out while exploiting the full measuring rate for both channels.

Due to a user-friendly web interface, no additional software is necessary to configure the controller and the sensors. Data output is via Ethernet, EtherCAT, RS422 or analog output.



Settings are made via the web interface. For thickness measurements, materials are stored in an expandable materials database.



Two sensors can be directly connected to a confocal IFC2422 controller.

Model	IFC2421	IFC2421MP	IFC2422	IFC2422MP
	Ethernet/EtherCAT		1 nm	
Resolution	RS422		18 bit	
	Analog		16 bits (teachable)	
Measuring rate	continuously adjustable from 100 Hz to 10 kHz ¹⁾			
Linearity	typ. < ±0.025 % FSO (depends on sensor)			
Multi-peak measurement	1 layer	5 layers	1 layer	5 layers
Light source	internal white LED			
No. of characteristic curves	up to 20 characteristic curves for different sensors per channel, selection via table in the menu			
Permissible ambient light ²⁾	30,000 lx			
Synchronization	yes			
Supply voltage	24 VDC ±15 %			
Power consumption	approx. 10 W			
Signal input	sync-in / trig-in; 2x encoders (A+, A-, B+, B-, index) or 3x encoders (A+, A-, B+, B-)			
Digital interface	Ethernet; EtherCAT; RS422; PROFINET ³⁾ ; EtherNet/IP ³⁾			
Analog output	Current: 4 ... 20 mA; voltage: 0 ... 10 V (16 bit D/A converter)			
Switching output	Error1-Out, Error2-Out			
Digital output	sync-out			
Connection	Optical	pluggable optical fiber via E2000 socket, length 2 m ... 50 m, min. bending radius 30 mm)		
	Electrical	3-pin supply terminal strip; encoder connection (15-pin, HD-sub socket, max. cable length 3 m, 30 m with external encoder supply); RS422 connection socket (9-pin, Sub-D, max. cable length 30 m); 3-pin output terminal strip (max. cable length 30 m); 11-pin I/O terminal strip (max. cable length 30 m); RJ45 socket for Ethernet (out) / EtherCAT (in/out) (max. cable length 100 m)		
Installation	Free-standing, DIN rail mounting			
Temperature range	Storage	-20 ... +70 °C		
	Operation	+5 ... +50 °C		
Shock (DIN EN 60068-2-27)	15g / 6 ms in XYZ axis, 1000 shocks each			
Vibration (DIN EN 60068-2-6)	2g / 20 ... 500 Hz in XYZ axis, 10 cycles each			
Protection class (DIN EN 60529)	IP40			
Material	Aluminum			
Weight	approx. 1.8 kg		approx. 2.25 kg	
Compatibility	compatible with all confocalDT sensors			
No. of measurement channels ⁴⁾	1		2	
Control and indicator elements	Multifunction button (two adjustable functions and reset to factory setting after 10 s); 5x LEDs for intensity, range, status and supply voltage			

FSO = Full Scale Output

¹⁾ Full measuring range up to 8 kHz. Sensor-dependent up to 80% FSO between 9 and 10 kHz.

²⁾ Illuminant: light bulb

³⁾ Connection via interface module (see accessories)

⁴⁾ No loss of intensity and linearity due to two synchronous measurement channels

IFC2421 Controller

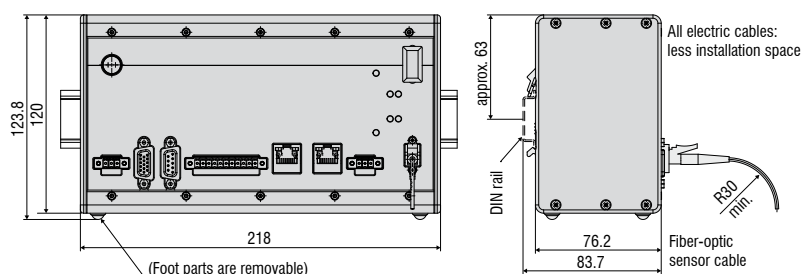



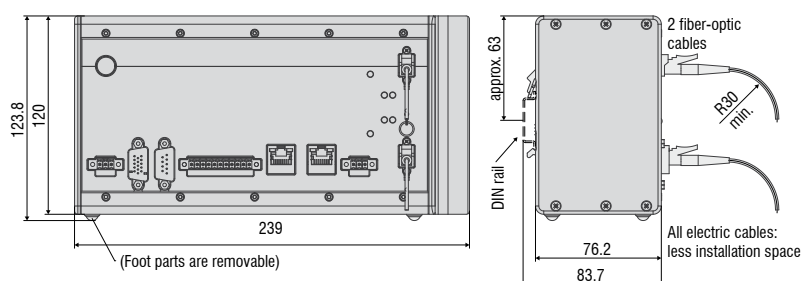





IFC2422 Controller



Light-intensive controller for high speed measurements

confocalDT IFC246x

-  Measuring rate up to 30 kHz
-  Ethernet / EtherCAT / RS422 / PROFINET / EtherNet/IP / Analog
-  Fast surface compensation and high light intensity
-  Configuration via web interface
-  Submicron resolution
-  Thickness measurement of multi-layer materials
-  Synchronous two-sided thickness measurement
-  Robust design with passive cooling



The confocalDT 2465 and 2466 controllers enable fast, high-precision distance and thickness measurements up to 30 kHz. The controllers are available as a single- or dual-channel variant. Using a special calculation function, the confocalDT 2466 dual-channel version evaluates both channels. Measurement acquisition is synchronous and can be carried out while exploiting the full measuring rate for both channels.

Available as a standard version for distance and thickness measurements as well as a multi-peak version, the controllers are compatible with all sensor types of the IFS series. The multi-peak models are used for the thickness measurement of up to 5 transparent layers.

Due to a user-friendly web interface, no additional software is necessary to configure the controller and the sensors. Data output is via Ethernet, EtherCAT, RS422 or analog output. Optionally available interface modules enable the data to be output also via PROFINET or EtherNet/IP.

High luminous intensity for challenging measuring objects

A controller version with high light intensity is available for measuring low-reflecting objects. Especially with tilted or dark surfaces, the enhanced light intensity increases the proportion of reflected light and enables stable measurements.



Settings are made via the web interface. For thickness measurements, materials are stored in an expandable materials database.

Model	IFC2465	IFC2465MP	IFC2466	IFC2466MP
Resolution	Ethernet/EtherCAT	1 nm		
	RS422	18 bit		
	Analog	16 bits (teachable)		
Measuring rate	continuously adjustable from 100 Hz to 30 kHz			
Linearity	typ. $\pm 0.025\%$ FSO (depends on sensor)			
Multi-peak measurement	1 layer	5 layers	1 layer	5 layers
Light source	internal white LED; high-power LED for variant with double light intensity			
No. of characteristic curves	up to 20 characteristic curves for different sensors per channel, selection via table in the menu			
Permissible ambient light ¹⁾	30,000 lx			
Synchronization	yes			
Supply voltage	24 VDC $\pm 15\%$			
Power consumption	approx. 10 W; approx. 20 W with double light intensity option			
Signal input	sync-in / trig-in; 2x encoders (A+, A-, B+, B-, index) or 3x encoders (A+, A-, B+, B-)			
Digital interface	Ethernet / EtherCAT / RS422 / PROFINET ²⁾ / EtherNet/IP ²⁾			
Analog output	Current: 4 ... 20 mA; voltage: 0 ... 10 V (16 bit D/A converter)			
Switching output	Error1-Out, Error2-Out			
Digital output	sync-out			
Connection	Optical	pluggable optical fiber via E2000 socket, length 2 m ... 50 m, min. bending radius 30 mm		
	Electrical	3-pin supply terminal strip; encoder connection (15-pin, HD-sub socket, max. cable length 3 m, 30 m with external encoder supply); RS422 connection socket (9-pin, Sub-D, max. cable length 30 m); 3-pin output terminal strip (max. cable length 30 m); 11-pin I/O terminal strip (max. cable length 30 m); RJ45 socket for Ethernet (out) / EtherCAT (in/out) (max. cable length 100 m)		
Installation	Free-standing, DIN rail mounting			
Temperature range	Storage	-20 ... +70 °C		
	Operation	+5 ... +50 °C		
Shock (DIN EN 60068-2-27)	15g / 6 ms in XYZ axis, 1000 shocks each			
Vibration (DIN EN 60068-2-6)	2g / 20 ... 500 Hz in XYZ axis, 10 cycles each			
Protection class (DIN EN 60529)	IP40			
Material	Aluminum			
Weight	approx. 1.8 kg		approx. 2.25 kg	
Compatibility	compatible with all confocalDT sensors			
No. of measurement channels ³⁾	1		2	
Control and indicator elements	Multifunction button (two adjustable functions and reset to factory setting after 10 s); 5x LEDs for intensity, range, status and supply voltage			

FSO = Full Scale Output

¹⁾ Illuminant: light bulb

²⁾ Connection via interface module (see accessories)

³⁾ No loss of intensity and linearity due to two synchronous measurement channels

IFC2465 Controller

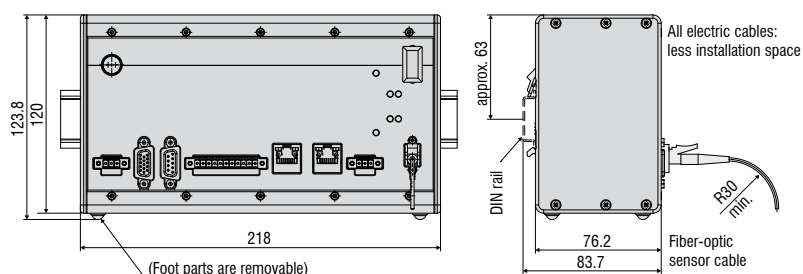

IFC2466 Controller

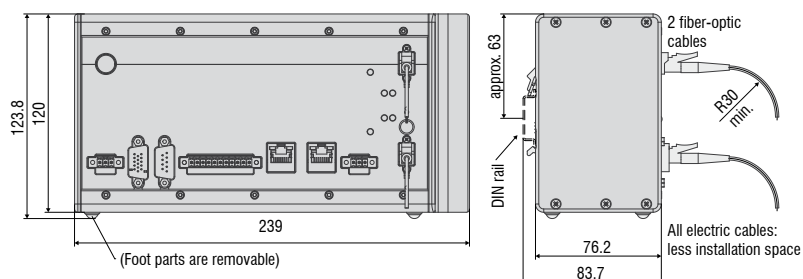

System design confocalDT

Cable concepts for every application

The connection options are diverse and can be adapted to your plant or machine concept.

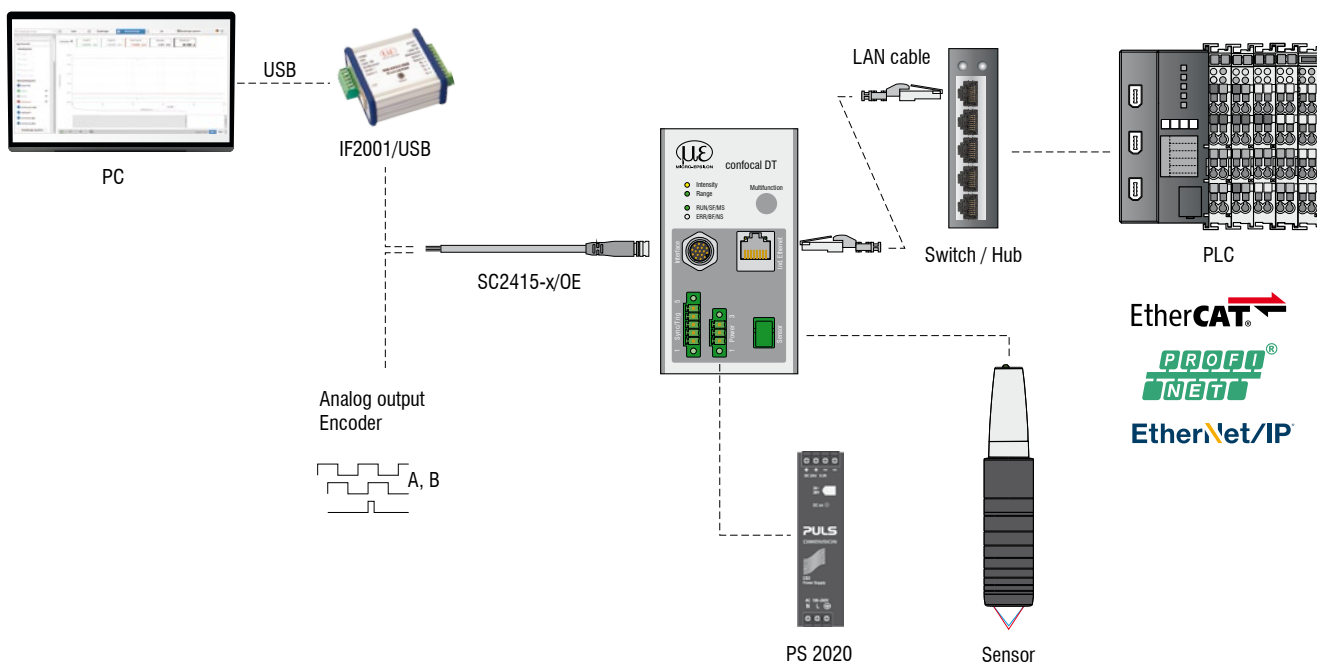
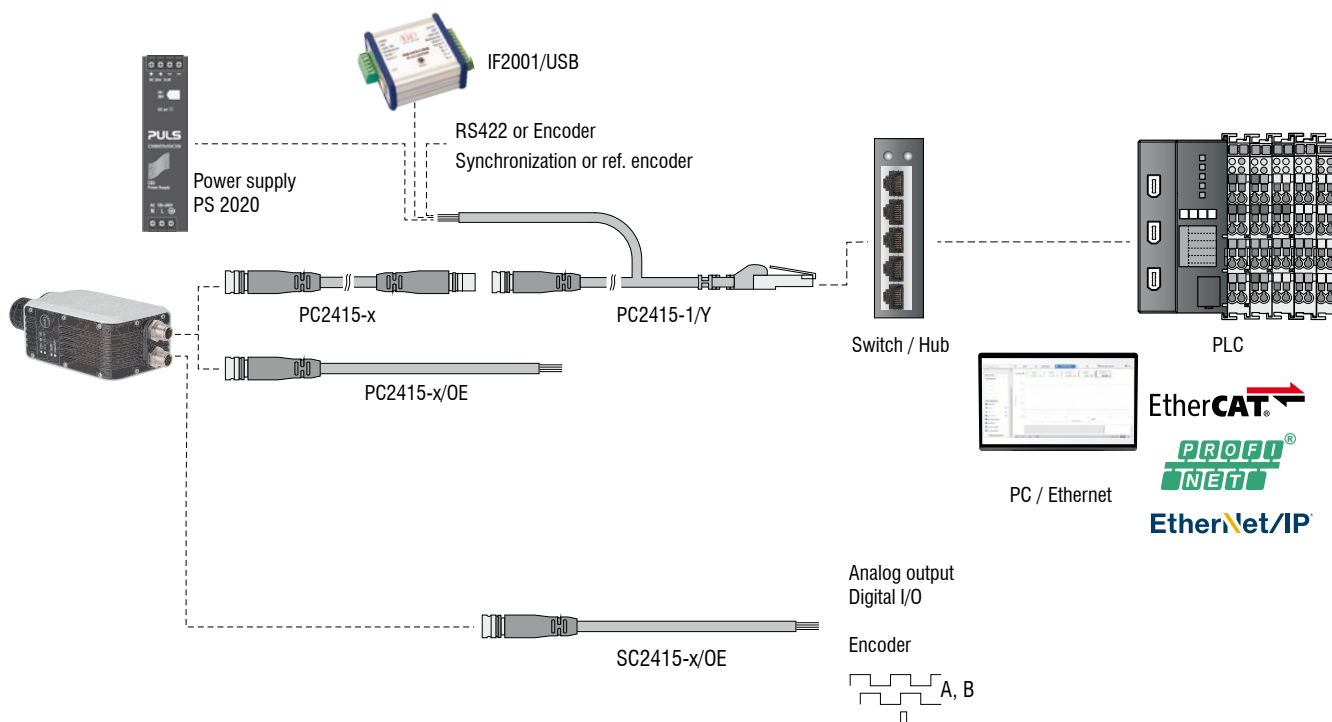

The confocalDT system consists of:

- Sensor IFS240x
- Controller IFC24xx
- Fiber optic cable C24xx

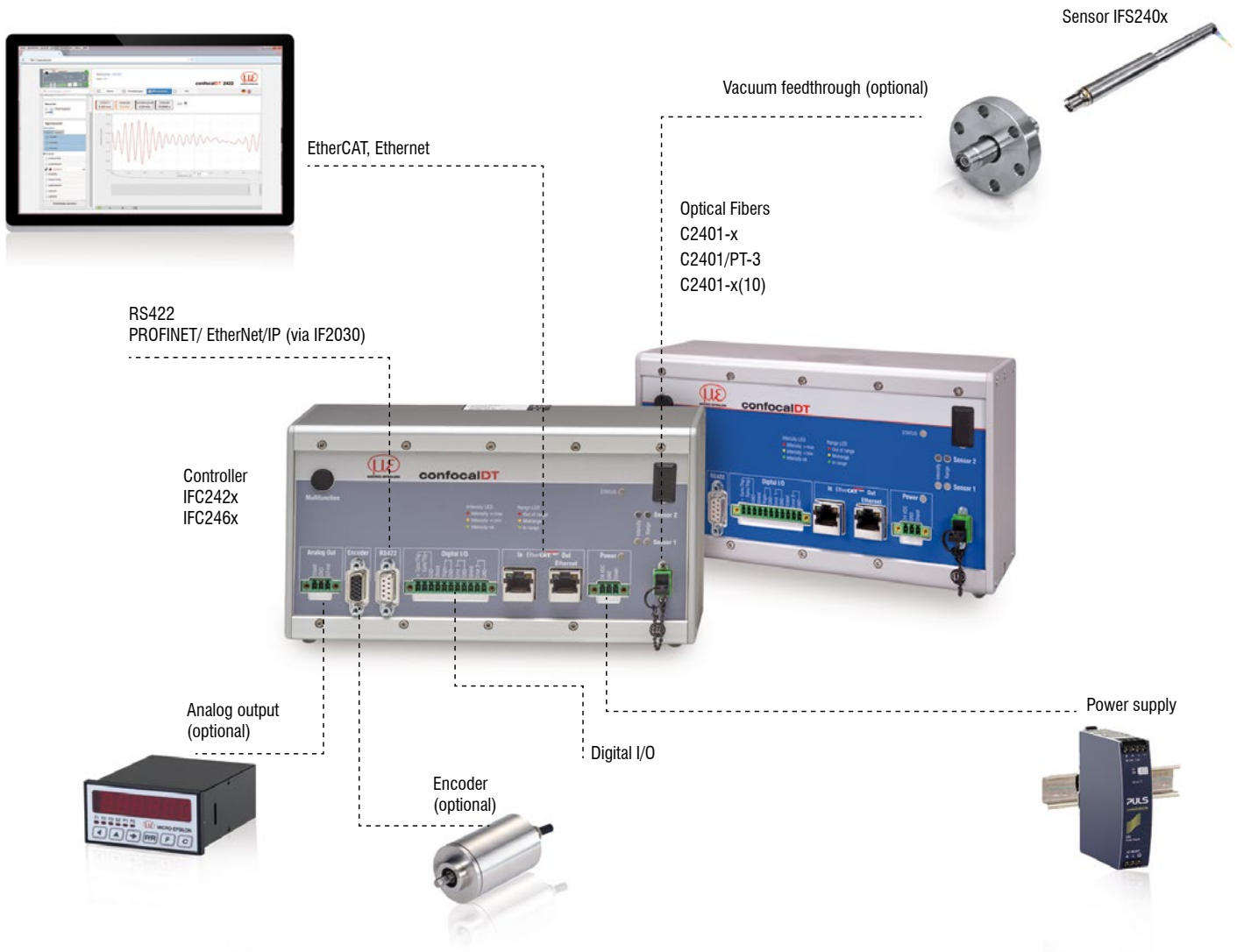

Customer-specific modifications confocalDT

Customer-specific modifications

Application examples are often found where the standard versions of the sensors and the controllers are performing at their limits. To facilitate such special tasks, it is possible to customize the sensor design and to adjust the controller accordingly. Common requests for modifications include changes in design, mounting options, customized cable lengths and modified measuring ranges.



Possible modifications

- Sensors with connector
- Cable length
- Vacuum suitability up to UHV
- Specific lengths
- Customer-specific mounting options
- Optical filter for ambient light compensation
- Housing material
- Measuring range / Offset distance

Vacuum setup

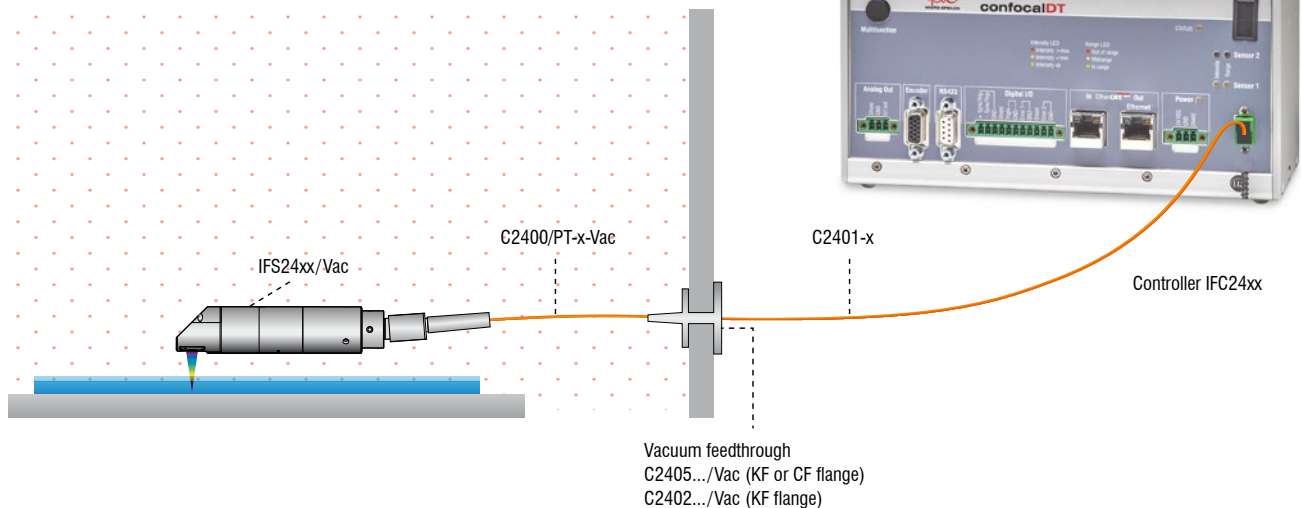

Accessories

Mounting adapter

Accessories: mounting adapter
MA2402 for sensors 2402

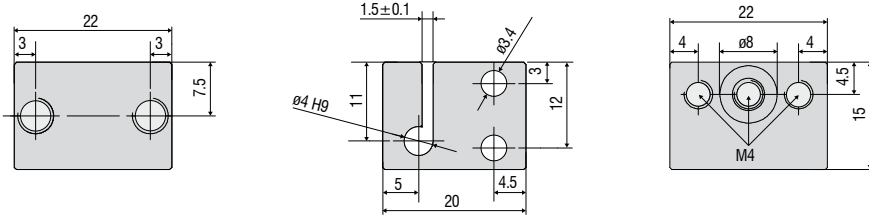

Accessories: mounting adapter
MA2403 for sensors 2403

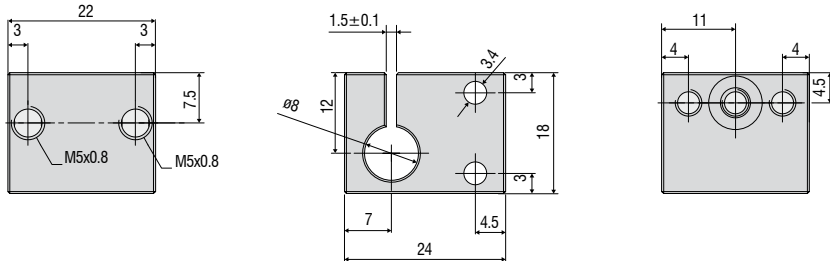

Accessories: mounting adapter
MA2404-12 for sensors IFS2404-2 / IFS2404/90-2 / IFS2407-0,1

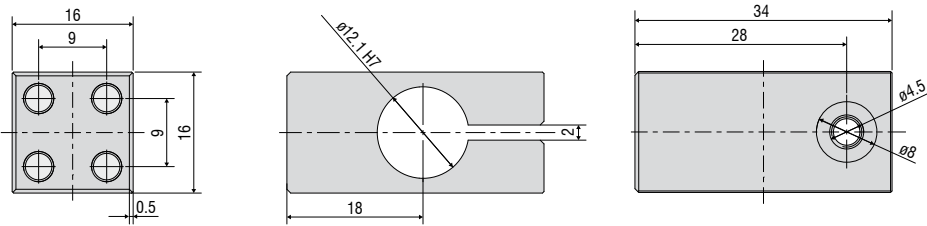

Accessories: mounting adapter
MA2400 for sensors IFS2405 / IFS2406 / IFS2407 (consisting of a mounting block and a mounting ring)

Mounting block

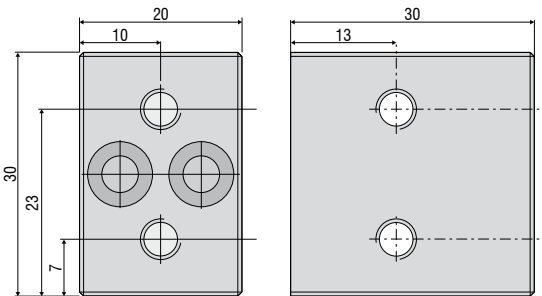

Mounting ring

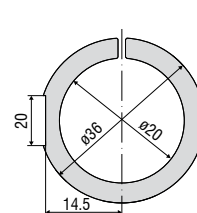

MA 2406-20 for sensors
IFS2406-2,5
IFS2406/90-2,5

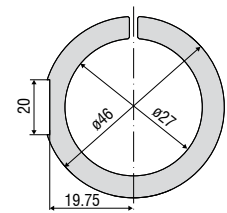

MA 2400-27 for sensors
IFS2405-0,3 / -1
IFS2406-3 / -10
IFD2411-x
IFD2410-x
IFD2415-1

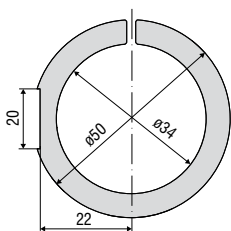

MA 2405-34 for sensors
IFS2405-3
IFD2415-3

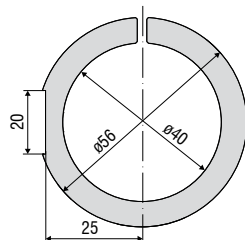

MA 2405-40 for sensors
IFS 2405-6

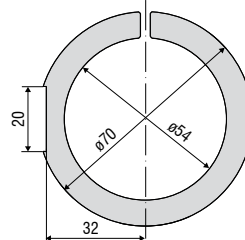

MA 2405-54 for sensors
IFS2405-10
IFS2407-3
IFD2415-10

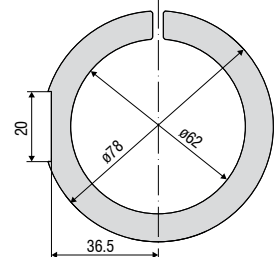

MA 2405-62 for sensors
IFS2405-28 / -30

Accessories

Adjustable mounting adapters

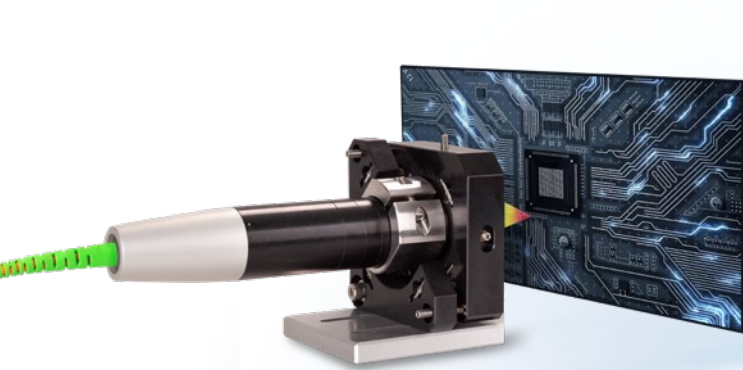

JMA-xx mounting adapter for distance measurements

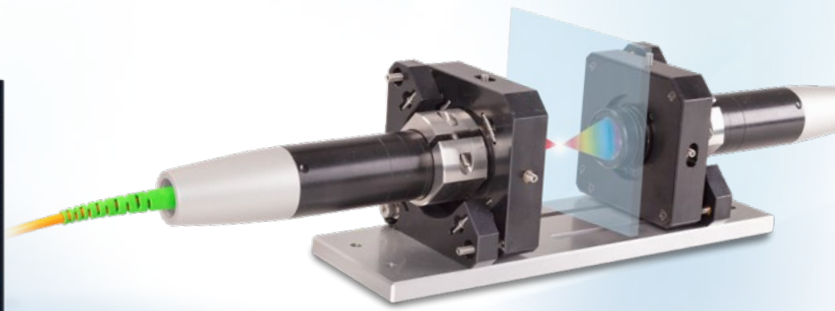

JMA-Thickness mounting adapter for two-sided thickness measurements

The adjustable JMA mounting adapter simplifies the alignment and fine adjustment of confocal sensors. The sensors are integrated and aligned directly in the machine together with the adapter. This corrects, e.g. minor deviations caused by mounting and compensates for tilted measuring objects. With two-sided thickness measurements, the JMA-Thickness mounting adapter supports the fine alignment of the two measuring points.

1 Max. shift in X ± 2 mm



2 Max. shift in Y ± 2 mm

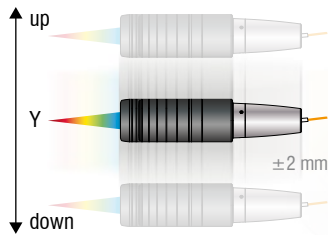

3 Max. tilt angle in X $\pm 4^\circ$

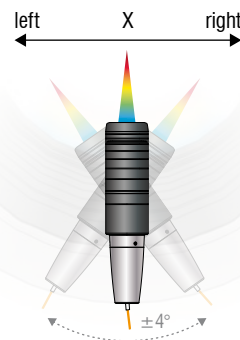

4 Max. tilt angle in Y $\pm 4^\circ$

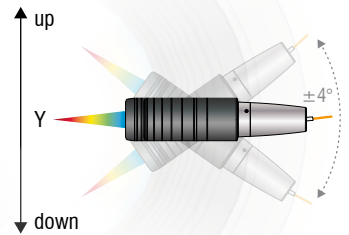

Dimensions

Adjustable mounting adapter JMA

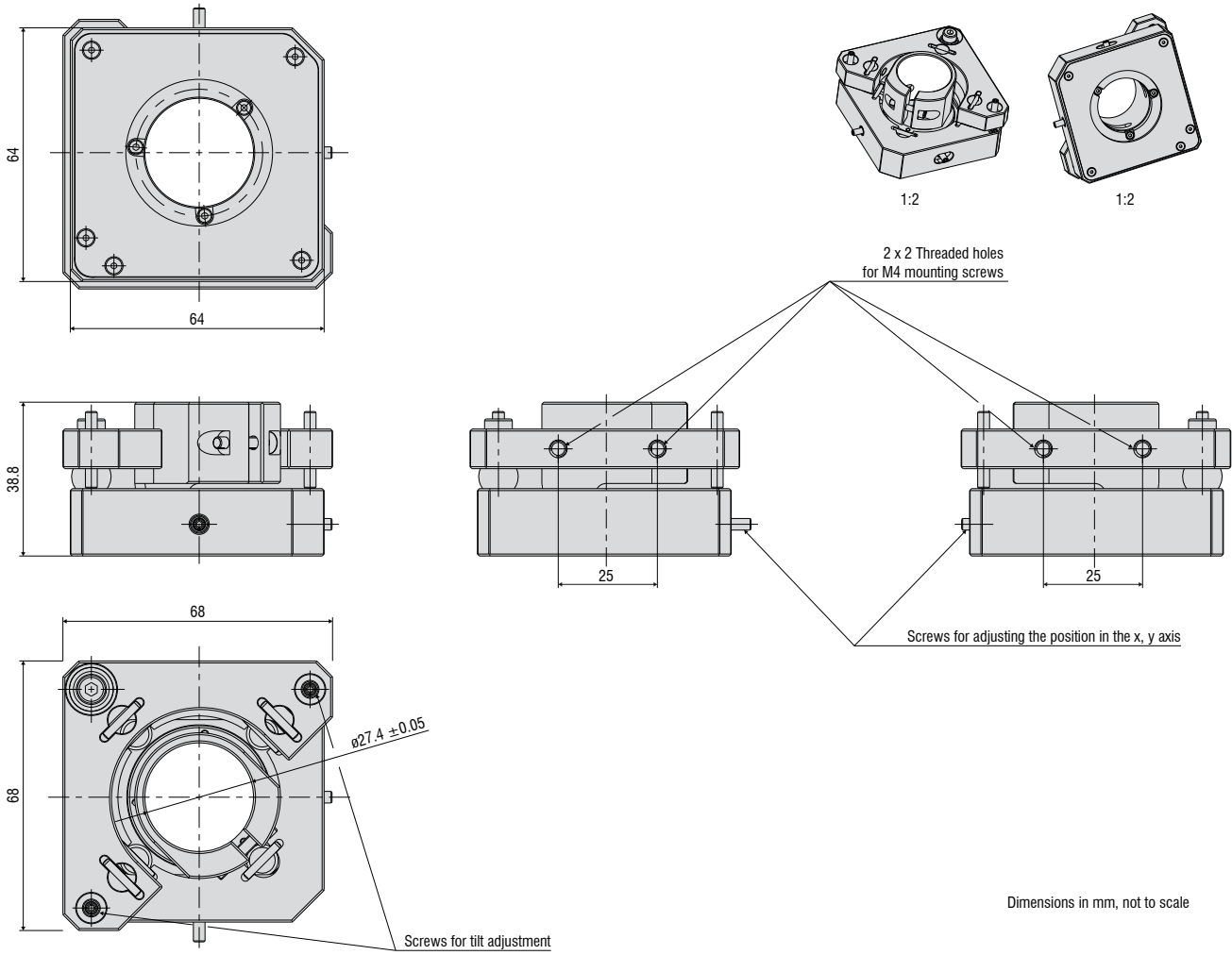

Holder for smaller sensor diameters

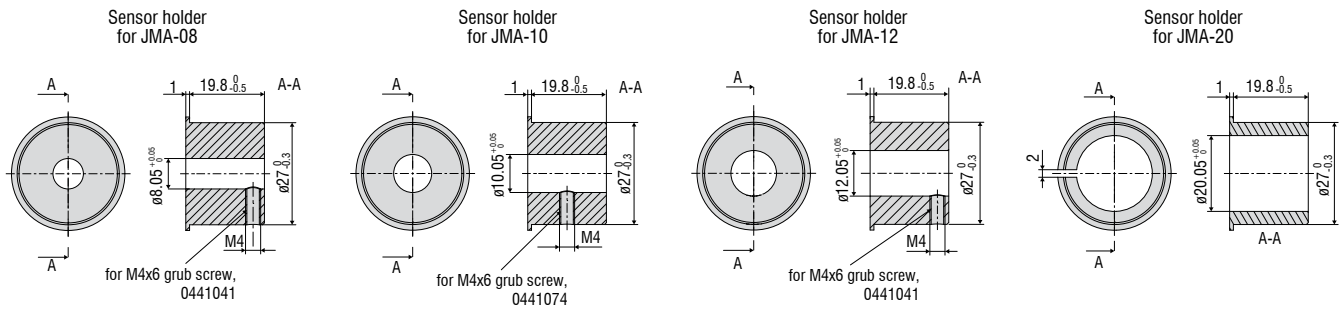

Mounting plate JMP for JMA-Thickness

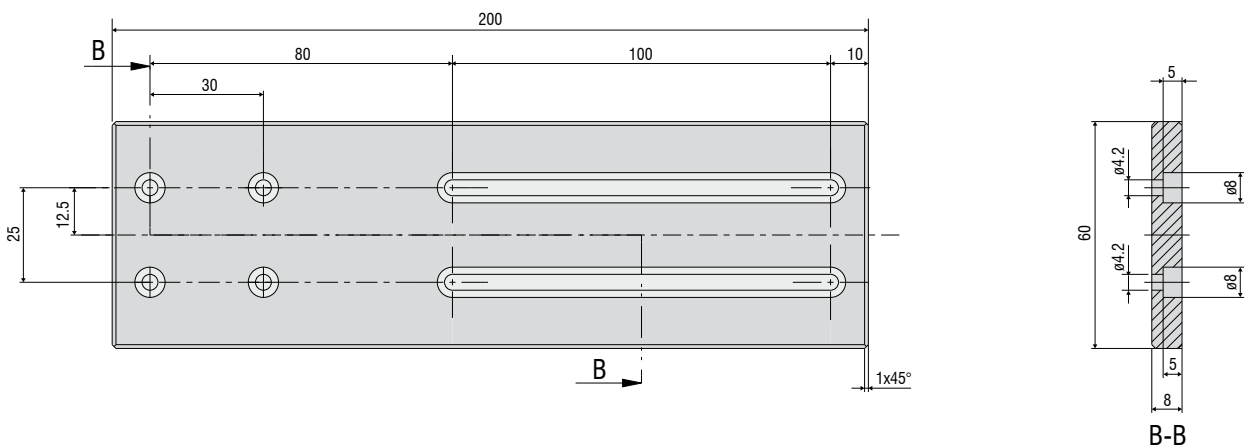

Mounting adapter for individual sensors

Manual adjustment mechanism for easy and fast adjustment

Optimal sensor alignment for best possible measurement results

Ideally suitable for machine integration

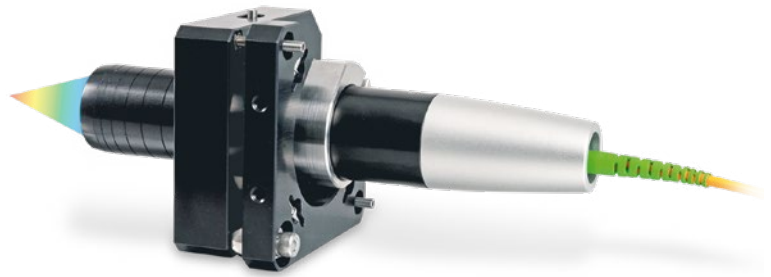

Particularly for high resolution sensors with a small tilt angle, perpendicular installation is required. The JMA-xx mounting adapter enables fine alignment of the sensor to the target via the simple adjustment mechanism. This makes it easy to compensate for minor mounting deviations or tilted measuring objects.

Scope of supply

- 1 JMA-xx
- 1 sensor holder for smaller diameters (not with JMA-27)
- 1 hexagon screwdriver for positioning
- Assembly instructions

Model	JMA-08	JMA-12	JMA-20	JMA-27
Tilting range	X Y	±4° (continuously adjustable)		
Shifting range	X Y	±2 mm (continuously adjustable)		
Shock (DIN EN 60068-2-27)	15g / 6 ms in XYZ axis, 1000 shocks each			
Vibration (DIN EN 60068-2-6)	2g / 20 ... 500 Hz in XYZ axis, 10 cycles each			
Adjustment mechanism	Screw setting mechanism via M3x0.25 screw with hexagon socket 1.5			
Installation	2x 2 mounting holes for M4x1			
Sensor mounting	Radial clamping for ø 8 mm	Radial clamping for ø 12 mm	Radial clamping for ø 20 mm	Radial clamping for ø 27 mm
Compatibility	confocalDT: IFS2403 series	confocalDT: IFS2404-2 IFS2407-0,1 IFS2407-0,8	confocalDT: IFS2406-2,5/VAC interferoMETER: IMP-TH70	confocalDT: IFS2405-0,3 IFS2405-1 IFS2406-3 IFS2406-10 IFD2411-x

Application examples:

Alignment

Subsequent correction of the mounting position

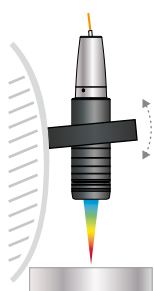

Compensates for incorrect target position

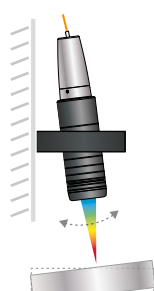

Positioning

Shifting the sensor to target area

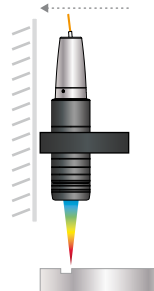

Mounting adapter for two-sided thickness measurements

Optimal alignment of the optical axes enables high precision in two-sided thickness measurements

Pre-assembled for easy installation and fast commissioning

Ideally suitable for machine integration

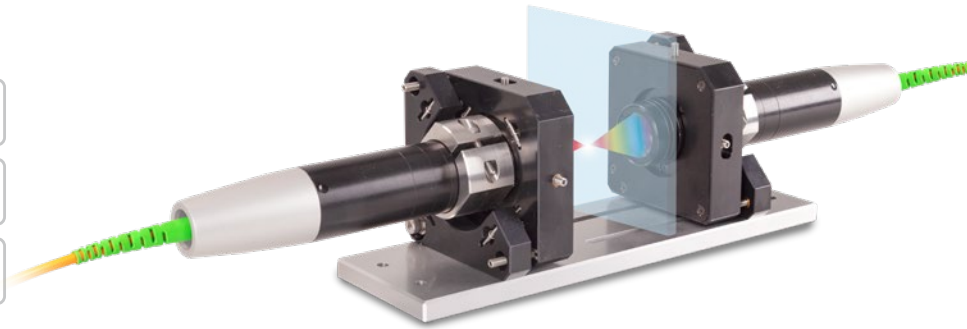

For two-sided thickness measurements, the JMA-Thickness mounting adapter supports the alignment of the measuring points to one another. This means that the measuring points are arranged absolutely congruent to each other so that the sensors are positioned exactly on an optical axis. This prevents measurements at an offset and a reliable measurement result is achieved with the highest possible precision.

When delivered, the two mounting adapters are pre-mounted on a mounting plate and aligned with one another. This simplifies installation and the measuring system can be put into operation more quickly. After installation into the machine, the plate can be removed, if necessary.

Scope of supply

- 2 JMA-xx
- 1 JMP mounting plate
- 1 hexagon screwdriver 1.5 mm
- 1 Allen wrench 2.5 mm
- 1 Allen wrench 3.0 mm
- 1 Assembly instructions
- 2 optional reducing sleeves
(depending on the package and the corresponding sensor)

Model	JMA-Thickness	-08	-12	-20	-27
Shock (DIN EN 60068-2-27)		15g / 6 ms in XYZ axis, 1000 shocks each			
Vibration (DIN EN 60068-2-6)		2g / 20 ... 500 Hz in XYZ axis, 10 cycles each			
Adjustment mechanism		Screw setting mechanism via M3x0.25 screw with hexagon socket 1.5			
Sensor mounting		Radial clamping for ø 8 mm	Radial clamping for ø 12 mm	Radial clamping for ø 20 mm	Radial clamping for ø 27 mm
Compatibility		confocalDT: IFS2403 series	confocalDT: IFS2404-2 IFS2407-0,1	confocalDT: IFS2406-2,5/VAC interferoMETER: IMP-TH70	confocalDT: IFS2405-0,3 IFS2405-1 IFS2406-3 IFS2406-10 IFD2411-x

More precision with two-sided thickness measurements

<p>Without JMA-Thickness: Measurement error with tilted target</p>	<p>Without JMA-Thickness: Incorrect thickness measurement with vibrations</p>	<p>Without JMA-Thickness: Sensors positioned incorrectly – no thickness measurement possible</p>
<p>With JMA-Thickness: Measures exactly at the opposite position</p>	<p>With JMA-Thickness: Sensors are on one optical axis – provides stability even with vibrating objects</p>	<p>With JMA-Thickness: Optimal positioning support – object visible for both sensors</p>

Accessories

Cables and connectors

Software

sensorTOOL Software demo tool included

Light source accessories

IFL2422/LED Lamp module for IFC2422 and IFC2466

IFL24x1/LED Lamp module for IFC2421 and IFC2465

Optical fiber extension for sensors

CE2402 cable with 2x E2000/APC connectors

CE2402-x Extension for optical fiber (3 m, 10 m, 13 m, 30 m, 50 m)

CE2402/PT3-x Optical fiber extension with protection tube for mechanical stress
(3 m, 10 m, customer-specific length up to 50 m)

Optical fibers for IFS2404/IFS2404-2 and IFS2404/90-2 sensors

C2404-x Optical fiber with FC/APC and E2000/APC connectors

Fiber core diameter 20 μm (2 m)

Optical fibers for IFS2405/IFS2406/2407-0,1/ IFS2407-3/IFD2411-x sensors

C2401 cable with FC/APC and E2000/APC connectors

C2401-x Optical fiber (3 m, 5 m, 10 m, customer-specific length up to 50 m)

C2401/PT3-x Optical fiber with protection tube for mechanical stress
(3 m, 5 m, 10 m, customer-specific length up to 50 m)

C2401-x(01) Optical fiber core diameter 26 μm (3 m, 5 m, 15 m)

C2401-x(10) Drag-chain suitable optical fiber (3 m, 5 m, 10 m)

C2400 cable with 2x FC/APC connectors

C2400-x Optical fiber (3 m, 5 m, 10 m, customer-specific length up to 50 m)

C2400/PT-x Optical fiber with protection tube for mechanical stress
(3 m, 5 m, 10 m, customer-specific length up to 50 m)

C2400/PT-x-Vac Optical fiber with protection tube suitable for use in vacuum
(3 m, 5 m, 10 m, customer-specific length up to 50 m)

Cables for IFD2410 /2415 sensors

PC2415-x Supply/interface cable, drag-chain suitable,
3 m, 6 m, 9 m, 15 m

PC2415-x/OE Supply/interface cable open ends, drag-chain suitable,
3 m, 6 m, 9 m, 15 m

PC2415-1/Y Supply/interface cable Y, open ends and RJ45 plug,
drag-chain suitable, 1 m

SC2415-x/OE Multifunction cable, open ends, drag-chain suitable,
3 m, 6 m, 9 m, 15 m

Cables for IFD2411 sensors

SC2415-x/OE Multifunction cable, open ends, drag-chain suitable, 3 m, 6 m, 9 m, 15 m

C2401-x Optical fiber (3 m, 5 m, 10 m, customer-specific length up to 50 m)



Optical fiber C2401-x



Optical fiber with coating C2401/PT3-x



Drag-chain suitable optical fiber C2401-x(10)

Optical fibers for IFS2407/90-0,3 sensors

C2407-x Optical fiber with DIN connector and E2000/APC (2 m, 5 m)

Vacuum feedthrough

- C2402/Vac/KF16 Vacuum feedthrough with optical fiber, 1 channel, vacuum side FC/APC non-vacuum side E2000/APC, clamping flange KF 16
- C2405/Vac/1/KF16 Vacuum feedthrough on both sides FC/APC socket, 1 channel, clamping flange type KF 16
- C2405/Vac/1/CF16 Vacuum feedthrough on both sides FC/APC socket, 1 channel, flange type CF 16
- C2405/Vac/6/CF63 Vacuum feedthrough FC/APC socket, 6 channels, flange type CF 63

Other accessories

- SC2471-x/USB/IND Connector cable IFC2461/71, 3 m, 10 m, 20 m
- SC2471-x/IF2008 Connector cable IFC2461/71-IF2008, 3 m, 10 m, 20 m
- PS2020 Power supply 24V / 2.5A
- EC2471-3/OE Encoder cable, 3m
- IF2030/PNET Interface module for PROFINET connection
- IF2030/ENETIP Interface module for EtherNet/IP connection

Optical fiber

Temperature range : -50 °C to 90 °C
 Bending radius: 30/40 mm

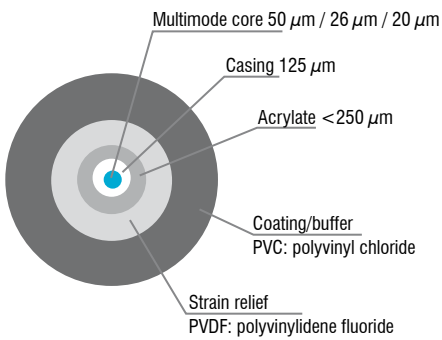

E2000/APC standard connector

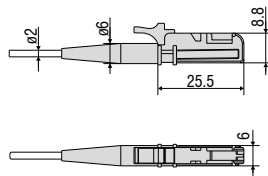

FC/APC standard connector

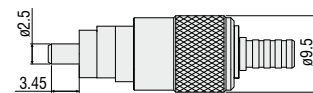

DIN connector

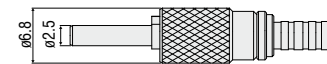

Accessories

Interface modules

Module	IFD2410	IFD2411	IFD2415	IFC242x	IFC246x
IF2001/USB Single-channel RS422/USB converter cable	✓	✓	✓	✓	✓
IF2004/USB RS422/USB converter to convert up to 4 digital signals to USB	⊘	✓	⊘	✓	✓
IF2008/ETH Interface module for Ethernet connection for up to 8 sensors	⊘	⊘	⊘	✓	✓
IF2008PCIE Interface card for multiple sensor signals; analog and digital interfaces	⊘	✓	⊘	✓	✓
IF2035/PNET Interface module for Industrial Ethernet connection (PROFINET)	⊘	⊘	⊘	✓	✓
IF2035/ENETIP Interface module for Industrial Ethernet connection (EtherNet/IP)	⊘	⊘	⊘	✓	✓

IF2001/USB converter RS422 to USB

The RS422/USB converter converts the digital signals of a confocal controller into a USB data packet. The sensor and the converter are connected via the RS422 interface of the converter. Data output is done via USB interface. The converter loops through further signals and functions such as laser on/off, switch signals and function output. The connected controllers and the converter can be programmed through software.

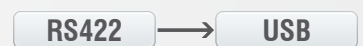
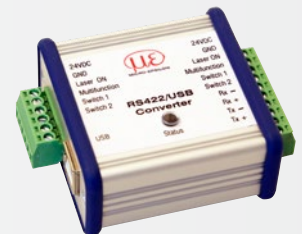

Special features

- Robust aluminum housing
- Easy sensor connection via screw terminals (plug and play)
- Conversion from RS422 to USB
- Supports baud rates from 9.6 kBaud to 12 MBaud

IF2004/USB: 4-channel converter from RS422 to USB

The RS422/USB converter is used for transforming digital signals of up to four confocal controllers into USB data signals. The converter has four trigger inputs and a trigger output for connecting additional converters. Data is output via an USB interface. The connected controllers and the converter can be programmed through software. The COM interfaces can be used individually and can be switched.

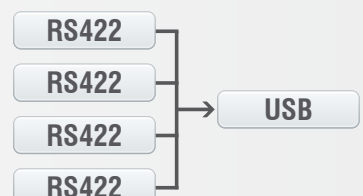

Special features

- 4x digital signals via RS422
- 4x trigger inputs, 1x trigger output
- Synchronous data acquisition
- Data output via USB

IF2008/ETH

IF2008/ETH Interface module for Ethernet connection with up to 8 sensors

The IF2008/ETH integrates up to eight sensors and/or encoders with an RS422 interface into an Ethernet network. Four programmable switching in-/outputs (TTL and HTL logic) are available.

10 indicator LEDs directly on the module show both the channel and the device status. In addition, acquisition and output of data via Ethernet is in addition performed at high speeds up to 200 kHz. Parameter setting of the interface module can be easily done via the web interface.



IF2008PCle/IF2008E

Interface card for synchronous data acquisition

Absolute synchronous data acquisition is a decisive factor for the deflection or straightness measurement using several controllers. The IF2008PCle interface card is designed for installation in PCs and enables the synchronous acquisition of four digital sensor signals and two encoders. The data is stored in a FIFO memory in order to enable resource-saving processing in blocks in the PC. The IF2008E expansion board enables to detect in addition two digital controller signals, two analog controller signals and eight I/O signals.

Special features

- IF2008PCle - Basic printed circuit board: 4 digital signals and 2 encoders
- IF2008E - Expansion board: 2x digital signals, 2x analog signals and 8x I/O signals

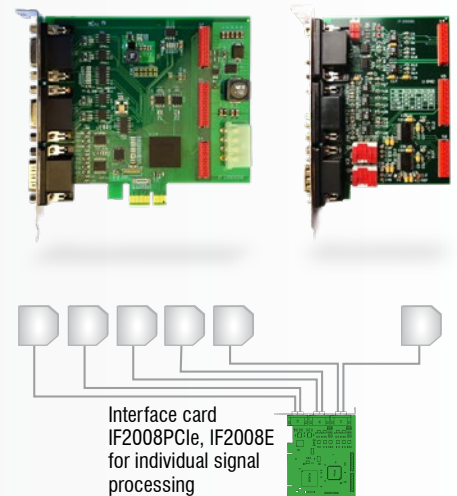

IF2035

Interface module for Industrial Ethernet connection

The IF2035 interface modules are designed for easy connection of Micro-Epsilon sensors to Ethernet-based fieldbuses. The IF2035 is compatible with sensors that output data via an RS422 or RS485 interface and supports the common Industrial Ethernet protocols EtherCAT, PROFINET and EtherNet/IP.

These modules operate on the sensor side with up to 4 MBd and have two network connections for different network topologies. In addition, the IF2035-EtherCAT offers a 4-fold oversampling function, which enables faster measurements than the bus cycle allows, if required. Installation in control cabinets is via a DIN rail.



Sensors and Systems from Micro-Epsilon



Sensors and systems for displacement, distance and position



Sensors and measurement devices for non-contact temperature measurement



Measuring and inspection systems for metal strips, plastics and rubber



Optical micrometers and fiber optics, measuring and test amplifiers



Color recognition sensors, LED analyzers and inline color spectrometers



3D measurement technology for dimensional testing and surface inspection